

# Pasture Planner

A GUIDE FOR  
DEVELOPING  
YOUR  
GRAZING  
SYSTEM



# Pasture Planner

## Sponsors

Revised Version 2017



Greener Pastures Ranching Ltd.

Original Document

Environmentally Sustainable Agriculture Initiatives Program





# Table of Contents

Grazing Systems .....	2
Developing your Pasture Plan .....	3
Calculation of Stocking Rate .....	10
STOCKING RATE WORKSHEET .....	12
Fencing Design and Equipment .....	13
Brace Assemblies .....	14
Temporary Fencing Methods .....	15
Electrical Fencing System .....	16
Power for gated areas.....	16
Livestock Handling Facilities.....	19
Moving in a corral .....	20
Watering Systems .....	22
Water Source Options.....	23
Moving the Water.....	23
Trough Space .....	24
Tank and Trough Options .....	25
Remote Locations.....	26
Extended Grazing .....	28
Pasture Assessment.....	30
Determining Pasture Condition.....	36

This Pasture Planner was created to assist producers with the development and/or modification of their grazing system. The Planner was originally written by Fraser Stewart and Michael Thiele of the Manitoba Forage Council (MFC) and edited by W. Cowan of WC Rural Resources, C. Arbuckle of Corie Communications and Glenn Friesen of Manitoba Agriculture, Food and Rural Initiatives (MAFRI). Further amendments by Fito Zamudio Baca of West-Central Forage Association (WCFA)

Additional information is available at:

**West-Central Forage Association:** [www.westcentralforage.com](http://www.westcentralforage.com)

**Alberta Agriculture and Forestry:** [www.agric.gov.ab.ca](http://www.agric.gov.ab.ca)

**Manitoba Forage Council:** [www.mbforagecouncil.mb.ca](http://www.mbforagecouncil.mb.ca)

**Ducks Unlimited Canada:** [www.ducks.ca](http://www.ducks.ca)

**Manitoba Agriculture, Food and Rural Initiatives:**

[www.gov.mb.ca/agriculture/crops/forages/](http://www.gov.mb.ca/agriculture/crops/forages/)

**University of Minnesota:** <http://www.extension.umn.edu/distribution/livestocksystems/DI7606.html>

**Saskatchewan Forage Council:** [www.saskforage.ca](http://www.saskforage.ca)

**Beef Cattle Research Council:** [www.beefresearch.ca/](http://www.beefresearch.ca/)

**Foragebeef.ca:** [www1.foragebeef.ca/\\$foragebeef/frgebeef.nsf/all](http://www1.foragebeef.ca/$foragebeef/frgebeef.nsf/all)

1<sup>st</sup> Edition published December 2009

2<sup>nd</sup> Edition March 2015

3<sup>rd</sup> Edition December 2017

# Grazing Systems

A grazing system involves the interaction of the following five components:



Producer



+ Livestock

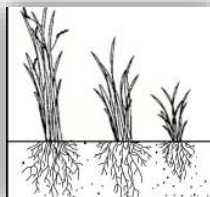

+ Forage

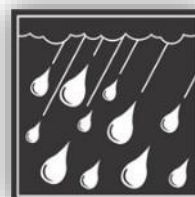

+ Weather



+ Land

Unfortunately, producers have no control over the weather and only limited control over forage production. To have a successful grazing system, producers must focus on the management of the two components they can control; land and livestock.

Producers can become adept at observing nature and adapting management methods to optimize production and sustain valuable landscape resources. Good grazing management is truly a combination of art and science-the art of observation and the science of agricultural production.

## Grazing Management Systems

### Continuous Grazing

A one-pasture system where livestock have unrestricted access throughout the grazing season.

### Simple Rotational Grazing

A system with more than one pasture in which livestock are moved to allow for periods of grazing and rest for forages.

### Intensive Rotational Grazing

A system with many pastures, or paddocks. Livestock are moved frequently from paddock to paddock based on forage growth and utilization.

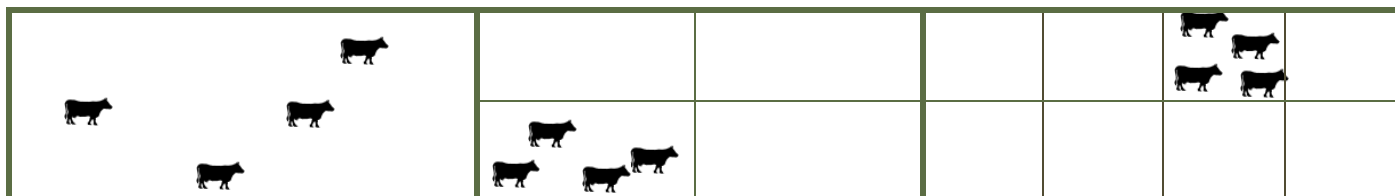

#### Advantages

- Requires less management
- Capital costs are minimal

#### Disadvantages

- Lower forage quality and yields
- Lower stocking rate and less forage produced per acre
- Uneven pasture use
- Greater forage losses due to trampling
- Animal manure is distributed unevenly
- Weeds and other undesirable plants may be a problem
- Difficult to maintain legumes and reestablish weakened areas

#### Advantages

- Can increase forage production and improve pasture condition over continuous grazing
- Allows pastures to rest and allows for forage regrowth
- Can provide a longer grazing season, reducing the need for feeding harvested forages
- Better distribution of manure throughout the pasture

#### Disadvantages

- Costs for fencing and water systems can be higher than with continuous grazing
- Forage production and pasture utilization is not as high as intensive rotational grazing systems

#### Advantages

- Highest forage production and use per acre
- Stocking rates can typically be increased
- More even distribution of manure throughout the paddocks, better nutrient cycling
- Weeds and brush are usually controlled through grazing
- Provides more grazing options and reduces the need for mechanically harvested forages

#### Disadvantages

- Requires careful monitoring of forage supply
- Initial costs may be higher due to fencing materials and water distribution systems
- Requires more management

# Developing your Pasture Plan

To develop a successful grazing plan you must first examine your objectives and the characteristics of both yourself and your farm.

## Objectives of a Grazing System:

- Control the grazing animals;
- Provide rest and recovery time for the plants;
- Extend the life of the most productive species in the pasture;
- Keep the plants in a vegetative state;
- Improve the nutritional value of the plants;
- Improve the soil fertility by growing nitrogen-fixing legumes and recycling crop residues;
- Lower the cost of feed by extending the grazing season.



## In order to implement a new plan you must:

- Be flexible with your farm operation;
- Understand the interaction between effective grazing and maximum productivity;
- Have adequate facilities and equipment to control your stock.

## Steps for Developing your Pasture Plan

### Step 1

Grazing resource inventory: determine what you have on your farm now. Identify the plant species and assess the level of management required to maintain the productivity of each one. How can you reduce the impact of poorer quality forages on your land?

### Step 2

Obtain aerial photographs or sketch out a map of your land. Contact your regional agriculture or county office for aerial photographers in your area or use the Google Earth website ([www.earth.google.com](http://www.earth.google.com)). Label your map with all the plant species and the available water sources.

### Step 3

Draw out some potential plans on paper – Involve your family in the process (page 31 has an outline for you to draw your existing and revised pasture plan).

## Keep in mind...

- What land resources are available: rented/ owned and what is the proximity of cropland and existing pasture systems?
- What is the productivity of the soils?
- Are there sensitive land areas or soil limitations for grazing in the pastures?

## What are the goals for your grazing system?

- Increase livestock numbers and/or forage availability?
- Improve animal performance?
- Reduce feed costs or labour?
- Reduce soil erosion?

**Examples of sensitive land areas to be identified and referenced on a map:**

- Location of surface waters (wetlands, lakes or streams)
- Quarries, mines or sinkholes
- Active or abandoned water supply wells
- Coarse-textured and high-leaching soils
- Steep slopes
- Shallow soil to a water table or bedrock
- Wooded areas
- Intermittent waterways.

**Examples of soil limiting features:**

- Sandy soils which have a high potential for drought
- Shallow soils over bedrock that limit the depth of root growth
- Flood-prone soils that either restrict growth of certain forages or limit grazing time
- Organic soils which limit accessibility and ability to withstand traffic
- Extreme slopes or landscapes that make pasture areas difficult to reach
- Solonchic soils.

The following chapters outline the items you should consider when sketching out your new pasture plan.

**Sample of a Pasture Plan**

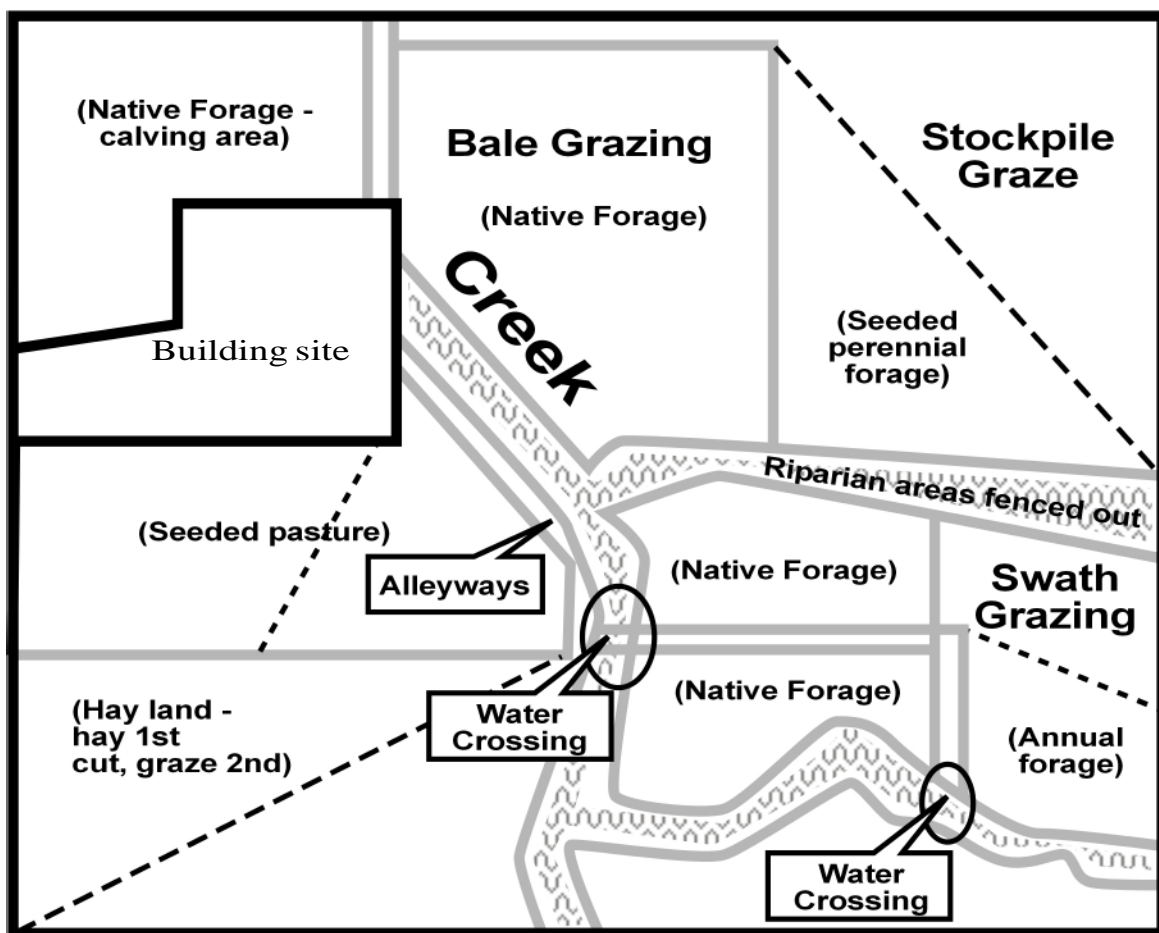

**LEGEND**

- Two-wire permanent fences
- Single-wire permanent fences
- - - Moveable, temporary fences

# Paddock Design and Layout

## Design and Layout

The development of a grazing plan involves the following:

- Determining how many paddocks are required and their size and shape;
- Determining the kind of fence and locations;
- Determining how water will be **provided** to the livestock.

An appropriate fencing type and design are required to control grazing and make efficient use of forage. Fencing systems will vary according to your land base; develop a system that is best for you.

In any pasture, livestock will graze the most palatable plants first, but without adequate control, will leave less palatable plants until later in the season or ignore them altogether. Managed grazing systems may be a fixed system with permanent fences and waterers or a flexible system with portable fences and waterers. Both portable and fixed systems generally have farm boundary fences with woven or barbed wire, or electrified, high-tensile smooth wire to ensure that all livestock is restrained on the farm and excluded from any cropland.

To revise your fencing system, start with a map or aerial photo of your land as it is today (available from most County offices).

Use page 45 to sketch your new fencing design.

Assess your land and label the:

- Seeded perennial pastures;
- Native forage areas;
- Annual forages;
- Areas that can be used for cut hay/pasture;
- Dominant plant species and areas in which they grow;
- Forage areas that can be used for stockpiling;
- Sensitive lands that are susceptible to wind and water erosion;
- Ditches, water courses or riparian areas that can leach off nutrients and;
- Other natural landscape features.

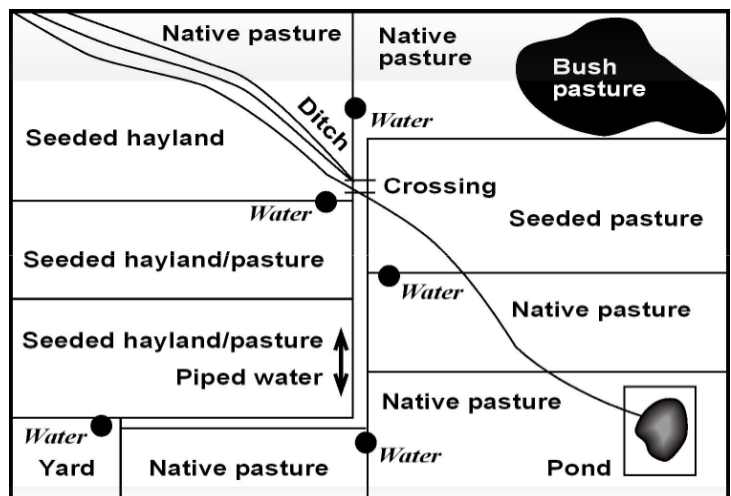

## Temporary fencing can be used to reduce the size of large paddocks

- Temporary fencing should be used to further subdivide the paddocks and increase stock density. A temporary electric net fence is an effective tool for managing sheep flocks and protecting them from predators.
- The use of poly-wire or airplane wire on a "take-up" reel is a quick way to adjust your pasture size. There should be at least eight permanent paddocks in a grazing cell.



**The paddocks should have:**

- Adequate stock density. The objective is to force the stock to graze all plants evenly and unselectively by crowding them in the paddock for a short period. The paddock can then be rested for an extended period to develop large, healthy roots and renewed lush top growth for the next grazing period.
- Alleyways that are well placed. They should be at least 23 feet wide (7 metres) to provide quick and easy access to the paddocks and watering sites.
- Wide alleyways minimize animal stress and allow for vehicle access.
- Alleyways that are located in high, dry areas so they are suited to all-weather travel.
- Water access. If the water is within 656 to 902 feet (200 to 275 metres), the animals will drink on an individual basis. Further distances encourage the animals to travel as a herd. The use of portable water systems, buried water lines and solar or wind powered pumps makes clean, fresh water accessible on most pastures

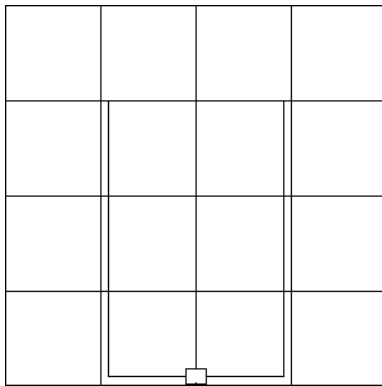

- Two Alley Ways**
- 4 miles of cross fence.
  - Even grazing.
  - Manure in alley.
  - Low labour costs.

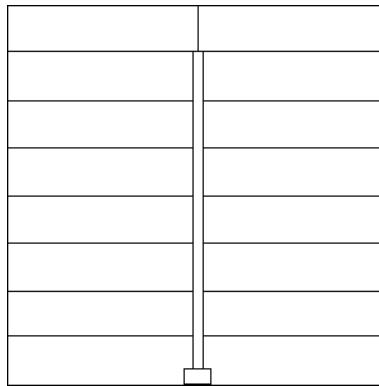

- One Alley Way**
- 4.4 miles of cross fence.
  - Uneven grazing.
  - Manure in alley.
  - Low labour costs.

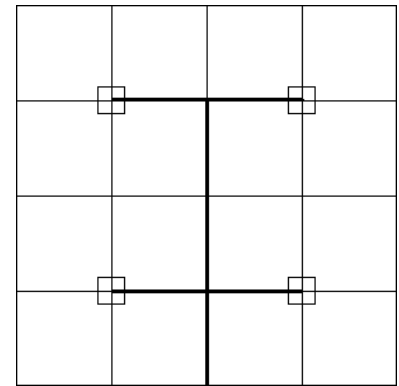

- Pipeline Method**
- 3 Miles of cross fence.
  - Even grazing.
  - Good manure distribution.
  - Increased capital costs.

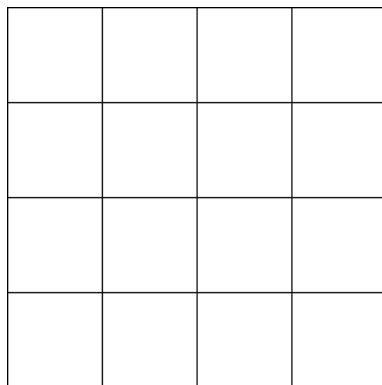

- Water Truck Method**
- 3 miles of cross fence.
  - Even grazing.
  - Excellent manure distribution.
  - Increased capital & labour costs.
  - Increased herd effect.

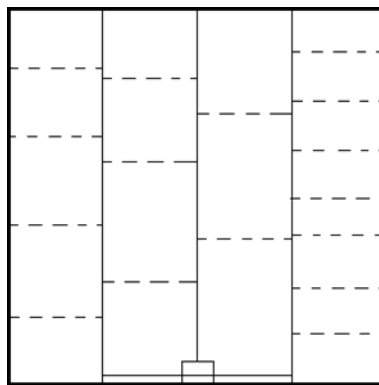

- Portable Strip Grazing**
- 1.5 miles of cross fence.
  - Two portable fences.
  - Variable utilization.
  - Higher labor costs.
  - Flexibility of paddock size.
  - Low capital costs.

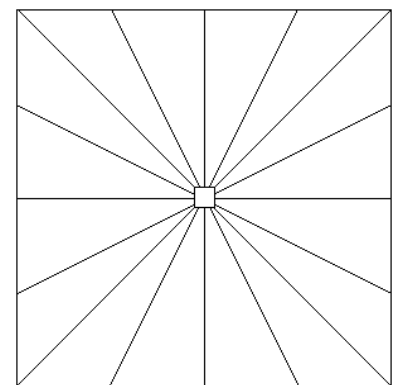

- Cell Center**
- 4.8 miles of cross fence.
  - Uneven grazing.
  - Fair manure distribution.
  - Low labour costs.
  - Variable manure distribution.



# Animal Control

## What is Overgrazing?

Overgrazing is when livestock are grazing a plant before it has had sufficient **TIME** to recover to late Stage 2 or Stage 3 Time is the key element here. When overgrazing occurs over and over again throughout growing seasons and from year to year, we get a condition many people call root bound. This describes a condition in which we have a mat of roots at the soil surface with very little roots reaching deeper.

Stage 3      Stage 2      Stage 1

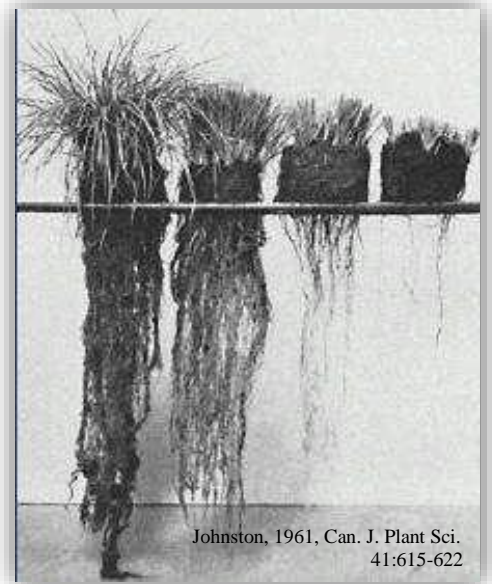

### Highly productive plants are:

- Legumes;
- Deep-rooted seeded grasses that have good re-growth potential and;
- Productive native species.

### Slower growing plants are:

- Native and seeded grasses that have poor productivity and re-growth.

### Lesser quality forages are:

- Shrubs and weeds.

### Native plants are:

- Cool season grasses such as fescue or warm species like needle grass;
- Better suited to harsh environments than introduced species; however, they require careful management because they are difficult to replace if lost.

## What is proper grazing management for the desired forage species?

When plants are grazed to the base or near to it, the plant does not have enough leaf surface to collect sunlight and undergo photosynthesis.

As a result, the first stage of growth uses energy from the root reserves. This prevents the roots from getting established and the plant becomes weak. Plants should be left at least 4 inches high so they can recover and establish a healthy root system.

To maintain desirable plants for grazing, pasture management must provide adequate rest from grazing in order to give desired species the competitive edge over less desirable plants. A good mix of desired plants within the pasture also benefits the grazing system by providing more ground surface coverage for as many days of the year as possible. Mixtures of grass and legume species that have different growth curves in the same pasture provide greater forage productivity than a single species pasture.

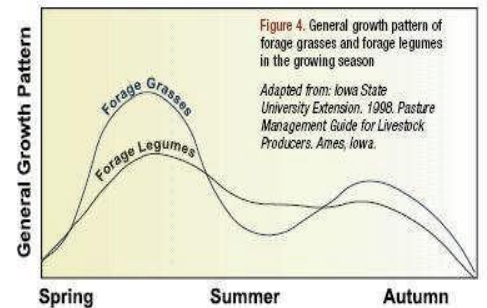

## Re-growth is dependent on the season.

- Early season–fast growth requires at least 20 days rest.
- Late season or drought–slow growth requires at least 30 days rest.

## Re-growth is also dependent on the species.

- Orchard grass re-grows faster than smooth brome.
- Bunch grasses with basal growing points re-grow quicker than sod forming or joint stemmed species.

Species	Cool Weather	Hot Weather
	(Days Rest)	
Cool Season Grasses	14	35-50
Warm Season Grasses	35-40	21
Legumes	21-28	21-28

## Stocking Rates

Stocking rate is usually expressed in "animal units/acres" or "head/acre". Time is often brought in by using the term "animal unit month".

Determine the stocking rate of a pasture system by using:

- Your previous experience with your pastures;
- Your hay yields and the resulting usage or surplus;
- Provincial guidelines.

Controlling your stocking rate provides time for the crop to rest, recover and establish a strong root system. The rate of rest varies according to the season but it is important to ensure the roots are replenished prior to the next grazing.

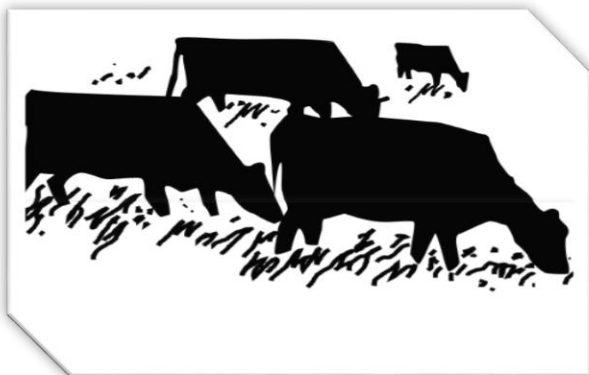

60 animals for 3 days provides a rest period for plants.  
Stock density = 20 animals per acre



One animal on pasture for 50 days will overgraze individual plants.  
Stock density = 1 animal per acre

## Commonly used Animal Unit Equivalents (AUE)

Class of Animal	AUE
Cow, 1000lb, dry	.92
Cow, 1000lb, with calf	1.00
Bull, mature	1.35
Cattle, 1 year old	.60
Cattle, 2 years old	.80
Horse, mature	1.25
Sheep, mature	.20
Lamb, 1 year old	.15
Goat, mature	.15
Kid, 1 year old	.10
Elk, mature	.60
Bison, mature	1.00

### Can nutrients from livestock manure be utilized more efficiently in pastures?

Nutrients are primarily removed from pasture ecosystems by making hay. Animals also remove nutrients through grazing. When pastures are grazed, many of the nutrients are returned to pastures via urine and feces. About 60-80% of the nitrogen, 60-85% of the phosphorus, and 80-90% of the potassium are excreted in urine and feces. Manure also contains many micronutrients needed by pasture plants. If manure is evenly distributed throughout the paddocks, fertility can almost be maintained through natural nutrient recycling. Often, a majority of the urine and feces is concentrated around water, shade, and other areas where

livestock congregate. This concentration of manure can lead to nutrient deficiencies in other parts of the pasture. Not only does concentration of manure around water and shade sites lead to lower pasture productivity, it also leads to greater opportunity for nitrate contamination of surface and ground water. To evenly distribute manure and increase soil fertility throughout the paddock, shorten the rotation, increase stocking rates, and place water, shade, salt, and supplemental feeders in nutrient poor areas. Minimize the amount of time animals spend around water by assuring the cattle do not have to travel more than 200-902 feet (200-275 metres) in each paddock.

# The modern Cow and Calf

A generation ago, most cows were of the traditional British breeds, weighed 750 to 950 lbs. and weaned a 305 lb. calf. Crossbreeding programs with mostly continental European breeds have increased cow size to an average of 1,200 to 1,300 lb. The range in cow weights extends from 1,000 to 1,600 lbs. These larger cows require more energy for maintenance and for greater milk production.

Calves are bigger too. The genetic changes that boost cow size also yield a larger-framed calf. This calf size combined with a general shift towards earlier calving, clearly suggests the modern calf requires more nutrition than the standard calf. The bottom line is that bigger cows and heavier calves graze more grass, so adjustments need to be made when matching livestock needs with available forage.

If producers stock their pastures with the same numbers of these larger animals as they once did with standard-sized animals and if they do not reduce the grazing period appropriately, overgrazing will result. The total livestock demand for forage will exceed the capability of the land to supply forage, and the grazed pasture will suffer. A practical solution is to adjust for changes in cow size on an Animal Unit equivalent basis by adding 0.1 AU for every 100 lb. increase in live weight above the standard AU.

For example, a 1,250 lb. lactating cow would constitute 1.25 AU. Figure 1 shows how this adjustment for cow size would be put into practice for 1,000 lb., 1,250 lb. and 1,500 lb. lactating cows with calves. The pasture with a carrying capacity of 100 AUMs would provide one month of grazing for 100, 80 and 67 head, in the preceding weight classes. This simple adjustment can also be applied to other classes of stock. (Adapted from Beef Cattle Allowance Tables, 1987, *Alberta Agriculture and Forestry*)

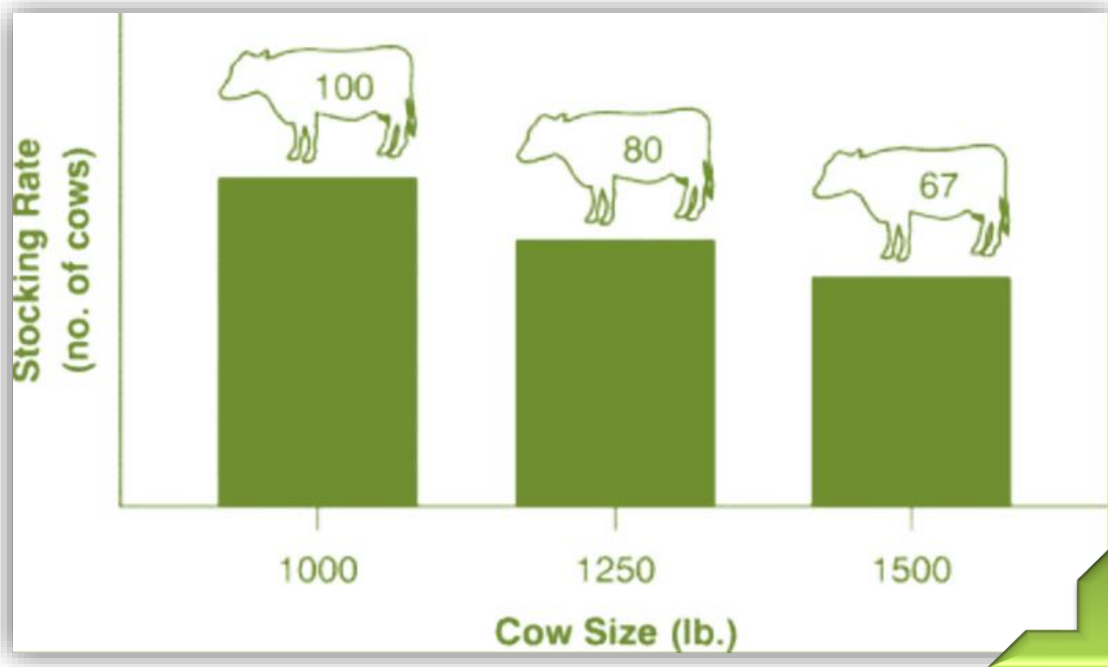

Figure 1. The number of cows that can graze a field with a carrying capacity of 100 AUMs for one month declines as cow size increases.

# Calculation of Stocking Rate

The stocking rate is the number of livestock in a given area over a set period of time. Failure to balance the livestock demand to the forage supply will result in over grazing or underutilizing pasture and result in declining pasture productivity.

Grazing management has three important variables:

- The number of animals in the pasture;
- The length of time in the pasture;
- The size of the pasture.

These variables are measured by using the Animal Days per Acre (ADA) formula.

Use the following method to calculate the stocking rate for pasture use. In this example a 20 acre paddock is producing 3000 pounds of forage per acre and grazing 600 lb steers.

## **Step 1. Determine average forage production per acre**

This is best calculated as pounds of forage per acre (lbs. DM / acre)  
Estimating forage production can be difficult – the two most important factors are plant height and plant density.

$$\text{lbs. of forage production per acre} = 3000 \text{ lbs. DM / acre}$$

## **Step 2. Determine forage utilization rate – lbs. DM useable forage per acre**

The grazing animal should not harvest every pound of forage produced – some must be left behind to ensure vigorous re-growth. The typical utilization rates for Alberta conditions are 50% giving rise to the 'take half, leave half' statement that wise grass farmers live by. Plan for enough margin in your utilization rate to buffer the risk of drought and wildlife feeding.

$$\underline{50\%} \text{ (utilization rate)} \times \underline{3000} \text{ (lb. of forage per acre)} = \underline{1500 \text{ lbs.}} \text{ (useable forage per acre)}$$

**Note:** The utilization rate for native pasture should be 50%. The tame pasture utilization rate is 50-75% depending on your fertility package. Remember that a management decision to increase the utilization rate has consequences such as reduced stand life and lower forage production in the future, but can be used for weed and woody regeneration control.

## **Step 3. Determine the livestock forage requirements - Animal Day (AD)**

Cattle will consume 2.5-3.0% of their body weight per day on a dry matter basis.

The amount of forage an animal will consume in a day is an Animal Day.

Cow/calf pair is approximately 2.5%. The calf is included with the cow until the calf is approximately 600 lbs. A 1500 lb. cow will consume 45 lbs./day. Use 3.0% for grassers and use the average weight during grazing season. For example if the steer starts at 600 lbs. and will end at 870 lbs., use 735 lbs. as the average summer weight.

$$\text{e.g. } (870 - 600 / 2) = 135870 - 135 = 735 \text{ lbs.}$$

$$\underline{1500 \text{ (lbs.)}} \text{ (cow weight)} \times \underline{3.0 \text{ (\% dry matter intake)}} = \underline{45 \text{ lbs/cow/day}}$$

#### Step 4. Determine Animal Days per Acre (ADA)

Once you know the useable forage per acre and the livestock requirements you can calculate the stocking rate for a particular paddock. Animal days per acre (ADA) is the forage utilization rate divided by the livestock forage requirement (AD).

$$\frac{1500 \text{ lbs. (useable forage DM per acre)}}{45 \text{ lbs./cow/day (AD)}} = 33 \text{ (ADA)}$$

#### Step 5. Use the ADA to calculate your stocking rate

Remember that the stocking rate is dependent upon the three variables, number of animals per pasture, the length of time in the pasture and the size of the pasture.

$$20 \text{ (acres)} \times 33 \text{ (ADA)} / 50 \text{ cows (herd size)} = 13 \text{ (grazing days)}$$

$$20 \text{ (acres)} \times 33 \text{ (ADA)} / 10 \text{ (grazing days)} = 66 \text{ cows (herd size)}$$

#### Calculating the Number of Paddocks Required

Paddocks are required to control the grazing animal and provide adequate time to rest the grazed forage. Generally, the more paddocks the better. Estimate the potential number of paddocks in a grazing system by using this formula.

$$\frac{\text{days rest}}{\text{Grazing days}} + 1 = \text{number of paddocks}$$

$$\frac{30 \text{ day rest period}}{5 \text{ days grazing per period}} + 1 = 7 \text{ paddocks required}$$

Once the number of paddocks have been determined, the grazing days can be adjusted to allow for a longer or shorter rest period. In the above example, 5 days is only the average grazing days per paddock – the actual will vary according to the regrowth rate.

**Fast Growth = Fast Moves \* Slow Growth = Slow Moves**

$$\frac{\text{days rest required}}{\text{number of paddocks resting}} = \text{grazing days/paddock}$$

$$\frac{\text{Fast growth period}}{18 \text{ days rest}} = 3 \text{ grazing days/paddock}$$

$$\frac{\text{Slow growth period}}{36 \text{ days rest}} = 6 \text{ days grazing/paddock}$$

#### Stock Density

Stock density is the number of animals divided by the number of acres per paddock. High stock density reduces selective grazing, thereby increasing the uniformity of grazing which promotes uniformity of growth. It also promotes uniform distribution of manure and urine and increases herd impact (trampling and fouling) which contributes to the health and productivity of the pasture for future grazing. To determine stock density, divide the total amount of DM forage produced over the season by the seasonal requirements of the animal (cow/calf pair or grasser) being grazed.

$$20 \text{ (acres)} \times (3000 \text{ lbs./ac} \times 50\% \text{ utilization}) / 45 \text{ lbs./cow/day} = 667 \text{ animal days.}$$

$$667 / 120 \text{ days grazing season} = 5.5 \text{ animals for the summer}$$

Stocking Rate Worksheet can be found on page 12.

## STOCKING RATE WORKSHEET

**Step 1. Determine average DM forage production per acre – lbs. of forage per acre**

Pounds of forage production / acre = lbs./acre

**Step 2. Determine forage utilization rate – lbs. useable forage per acre**

50% (utilization rate) x \_\_\_\_\_ (lbs. of forage / acre) = \_\_\_\_\_ Lb (useable forage / acre)

**Step 3. Determine the livestock forage requirements-Animal Day (AD)**

\_\_\_\_\_ (lbs. cow weight) x \_\_\_\_\_ (%Dry matter intake) = \_\_\_\_\_ lbs/cow/day (AD)

**Step 4. Determine Animal Days per Acre (ADA)**

lbs. (useable forage per acre) / \_\_\_\_\_ lbs./cow/day (AD) = \_\_\_\_\_ (ADA)

**Step 5: Use the ADA to calculate your stocking rate**

\_\_\_\_\_ (acres) x \_\_\_\_\_ (ADA) / \_\_\_\_\_ cows (herd size) = \_\_\_\_\_ (grazing days)

OR:

\_\_\_\_\_ (acres) x \_\_\_\_\_ (ADA) / \_\_\_\_\_ (Grazing days) = \_\_\_\_\_ cows (herd size)

## Paddock Calculation Worksheet

Days rest + number of animal groups = number of paddocks required  
grazing days

# days rest + number of animal groups = \_\_\_\_\_ paddocks required  
\_\_\_\_\_ grazing per period

### Days rest required

Number of paddocks resting = Grazing Days

*Fast growth period*

18 days rest = 3 days grazing/paddock  
6 paddocks

*Slow growth period*

36 days rest = 6 days grazing/paddock  
6 paddocks

# Fencing Design and Equipment

Fencing is a tool for controlling livestock. The fencing system should be flexible so it can accommodate changes in forage quantity and quality, animal density, renovation activities and harvesting of surplus hay.

When deciding what kind of fence you should install consider:

- Purpose of the fence
- Kind and class of livestock to be contained
- Operator preference
- Predator control
- Cost

## Options for Fencing Systems:

Many fencing systems utilize a combination of permanent high tensile fencing with temporary fencing. Some grazing managers choose to make permanent perimeter fences and use temporary electric fencing within.

### Barbed Wire

Barbed wire: traditional, permanent, costly, low maintenance.

- Provides a physical barrier that is not easily moved;
- Good for use as exterior fence;
- Barbed wire should never be electrified due to the increased potential of injury to livestock.

### Woven Wire Fences

A permanent fence that is primarily used for sheep and hogs.

- Not dependent on electrical power as it can not be powered;
- Labour intensive to install and not easily moved;
- Provides a nearly predator proof exterior fencing for smaller livestock.

### Temporary Fences

The primary use of temporary fencing is to define paddocks within a permanent perimeter fence. This will help

direct grazing within the defined area to underutilized areas, and can allow easy adjustment of the layout as producers learn what size paddock they need, how to accomplish livestock movement and how forages react to managed grazing. After gaining experience, producers usually prefer to install some type of permanent fencing to define paddocks and lanes.

Heavy duty poly-wire or airplane cable with a take-up reel allows for easy subdivision of paddocks.

## High Tensile Electric Fencing Systems

An electric fence teaches the animals to avoid the fence. Posts are spaced further apart than for barbed wire fences and the line posts are used to hold the fence/wire up. Typically perimeter fences are 3-4 strands of wire and interior fences are 1-2 strands of wire.

High tensile electric is lower in cost to install, versatile, easier to erect but higher maintenance than barbed wire.

- High tensile galvanized steel wire 12.5 gauge has a strength of 1,800 lbs;
- Has a high degree of elasticity-will stretch and return to original length;
- Very effective conductor of electricity;
- Safe for animals;
- Provides reasonable

livestock restraint and predator protection;

- Is easy to handle once techniques are mastered.

The use of poly-wire/airplane cable, step-in posts and a take-up reel makes the subdivision of paddocks a quick process.

## Handling Techniques

- Wire is easily broken if kinked or bent;
- Wire may be spliced using the reef or figure eight knot;
- Joins can be made without the aid of tools.

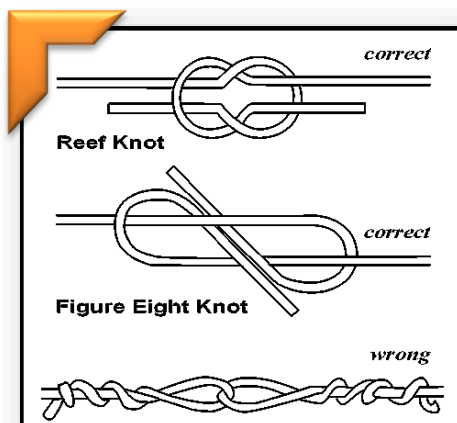

# Brace Assemblies

Brace assemblies are the key to a strong fence and must be properly installed.

## Horizontal end brace

- Top horizontal brace should be 2.5 times the height of the fence.

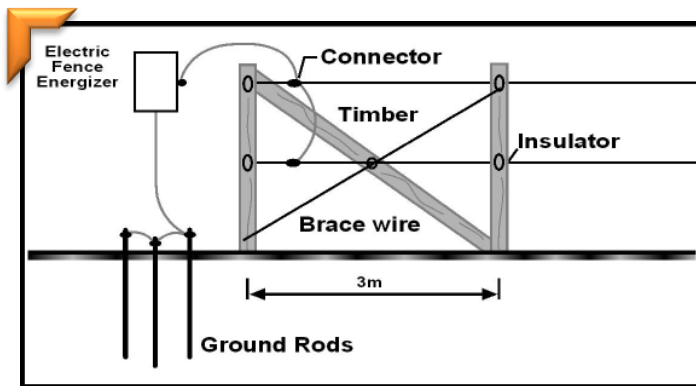
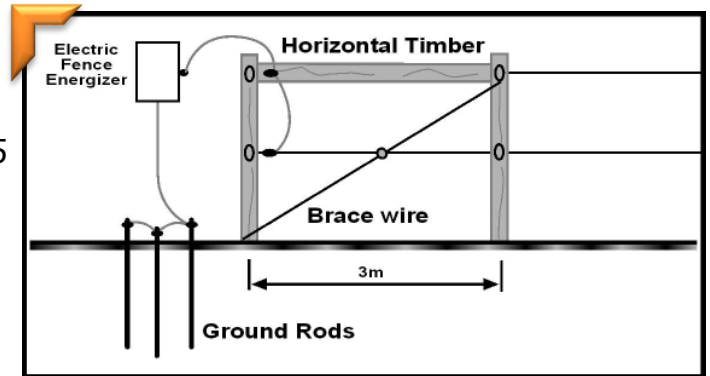

## Diagonal end brace

- To prevent an electrical short, ensure the diagonal brace wire does not come into contact with the ground or electrical wires.

## Single post end brace with dead-man anchor

- Thickness of the post and the depth of the soil will determine the strength of this unit;
- Dead-man attachment can be a screw-anchor or an anchor wire attached to a rock buried in the soil.

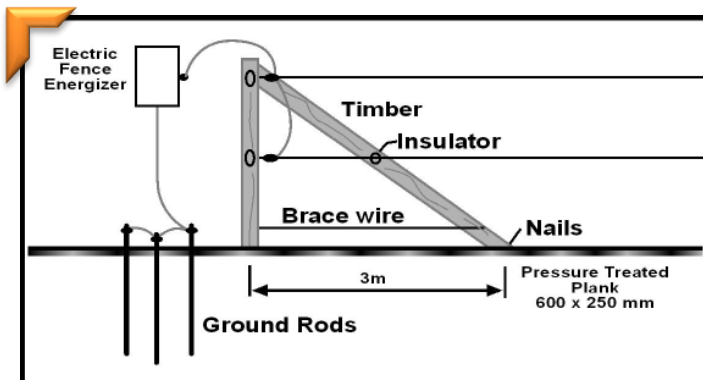
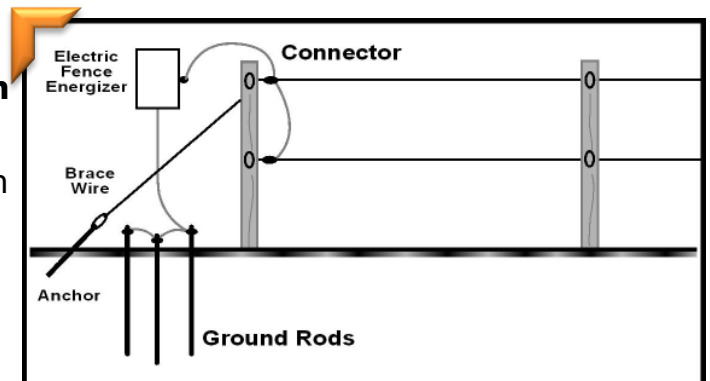

## Angle end brace

- Very simple system;
- The end of the angle brace must be floating on pressure treated wood or a stone plate;
- A horizontal brace wire runs from the bottom of the post to the angle member to provide strength.



# Temporary Fencing Methods

- Heavy duty poly-wire or airplane cable on a take-up reel with a geared drive rolls up as fast as you can walk;
- Step-in fiberglass or insulated posts are preferred for their ease of use;
- In frozen ground a battery-operated drill is an effective way to make holes in the ground to set the posts.

- 20 ft. spacing is preferred to keep the wire taut and prevent loose wire from catching the wool.

## Electric net fencing

- Used for temporary fencing for sheep or poultry;
- Easily erected or moved;
- Effective for predator control.

## Line Posts

- High tensile electric fence posts are used to hold up the wire;
- The distance between the line posts varies with the terrain;
- Increasing the number of posts improves fence visibility.

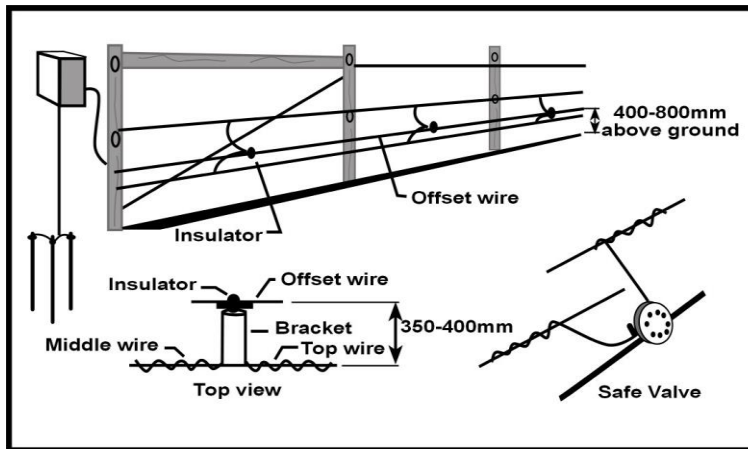

## Offset electric fencing

- Electric wire offset inside older fencing can be used to teach animals to avoid the fence line. This can extend the life of the older fence;
- Fastening an electric wire directly

## For cattle fencing:

- On high tensile electric wire use 50 - 60 ft. post spacing on the perimeter and subdivision fences;
- 60-80 ft. spacing for single wire subdivisions;
- 30 ft. spacing for alleyways or where there will be minimal animal pressure.

in line with an existing barbed wire fence is not recommended due to potential harm to animals and humans. If the barbs catch them they will be continuously shocked by the electrified

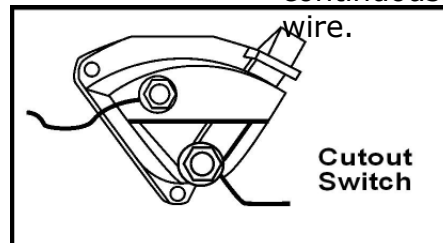

## Cut out switches

- Used to cut/transfer sections of fencing as required and isolate/identify short circuits;
- Not required to go all the way to the energizer;
- When a particular section is not being used, power can be cut off and used effectively elsewhere.

## For sheep fencing:

- 40-50 ft. spacing on fences with 4 wires can be used;

## Insulators

- Prevent leakage of electric current;
- They must be of good quality; porcelain is not recommended as it cracks. Plastic is better since it has a high density and can resist ultra violet rays and extreme cold.

### Post Insulators

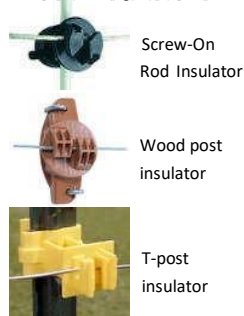

### Corner Insulators

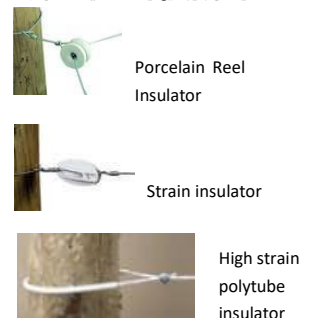



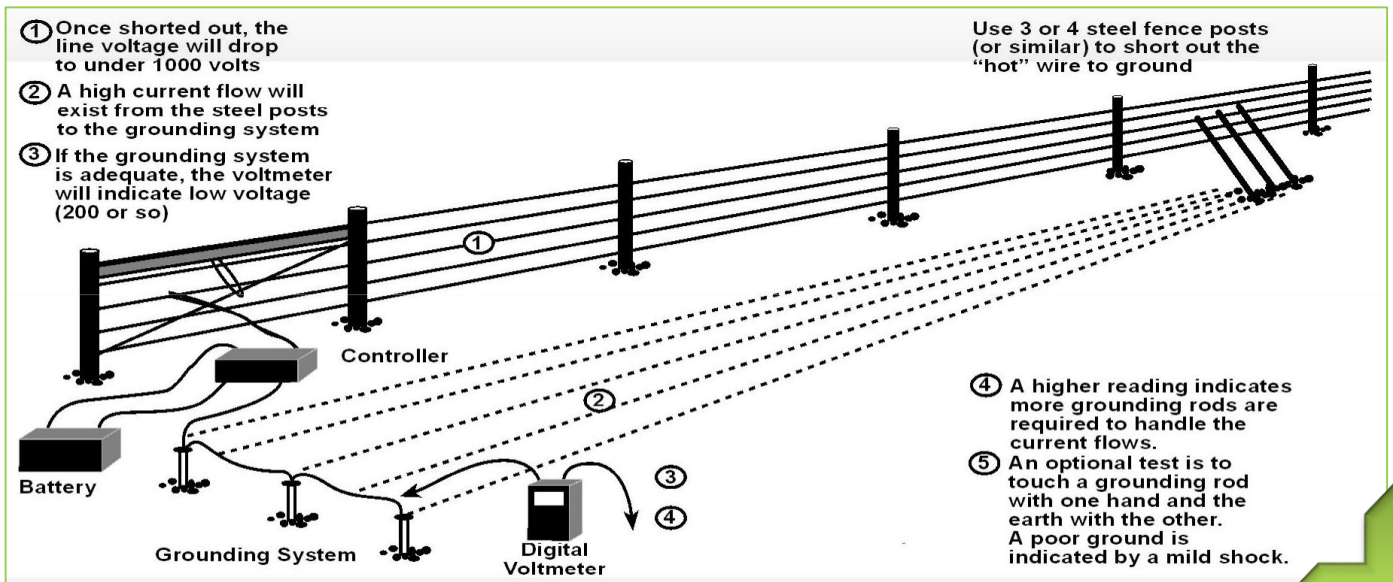

## Grounding

A major reason for the failure of electric fencing is poor grounding.

The system should have:

- At least three ground rods that are 6-9 feet long and spaced 9 feet apart;
- The general rule is three feet of ground rod per joule of energizer;
- Galvanized rods-steel rods corrode;
- Separate rods-never share with hydro poles or well casing (a galvanized culvert can be very effective as a grounding source);
- Galvanized or stainless steel metal clamps to connect the wire to the ground.

Frequently check the effectiveness of the grounding system by using a digital voltmeter. If the reading is higher than 500 volts, additional ground rods are required.

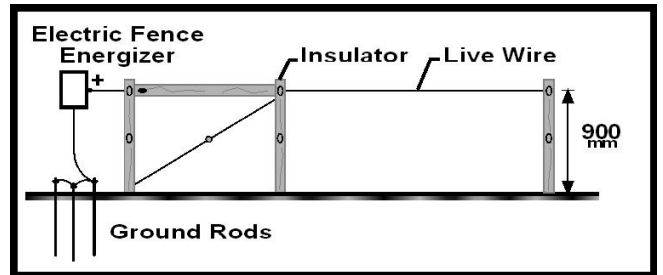

Normal Ground Grounding (Wet Soil)

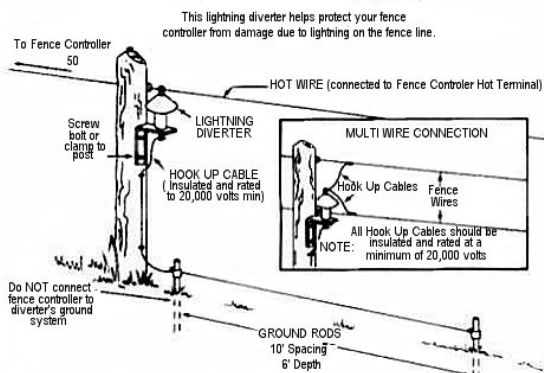
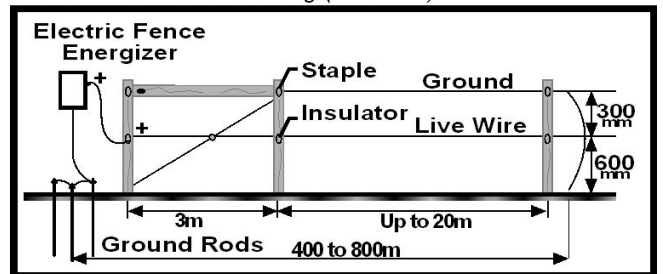

## Lightning Diverter

- A diverter is used to protect the energizer from lightning strikes and power surges.
- A choke kit (homemade) acts as a resistance to deflect the electrical surge through the diverter to the ground.

# Fence Types

## Single wire fence

- Most common form for subdividing;
- Set at about 36 inches in height;
- Requires moist soil to provide enough shock;

## Double wire fence

- Use a second wire if the soil is very dry, and in winter months.

## Three wire fence

- Used primarily for dairy and beef cattle;
- Two live wires with a middle ground wire;
- 60 feet post spacing;
- Used for alleyways.

## Four wire fence

- Used for cattle and horses;
- Requires jumper wires to connect the electrified wires together and the ground wires together.

## Five wire fence

- Primarily used for sheep and goats;
- Jumper wires are used to connect all positive and negative wires together. This ensures a good connection.

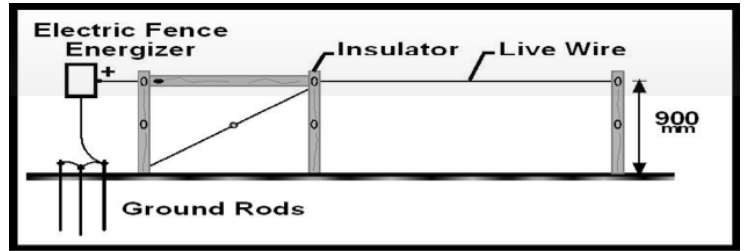

Normal Ground Grounding (Wet Soil)

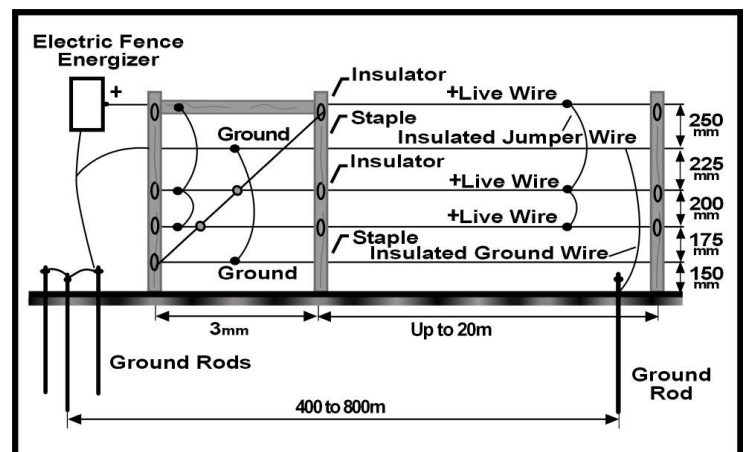
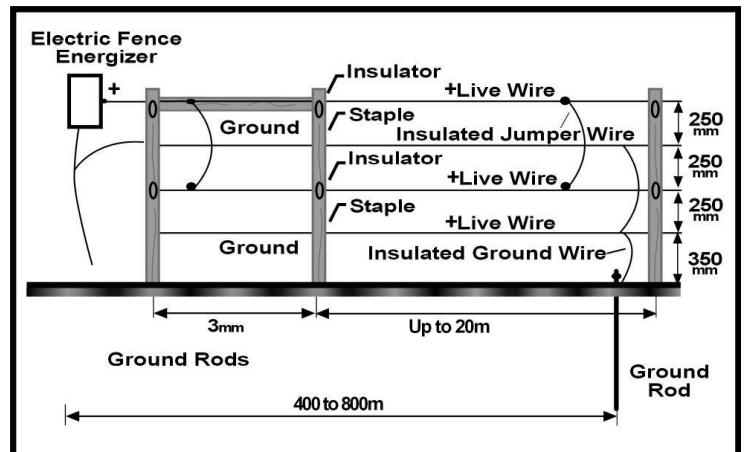
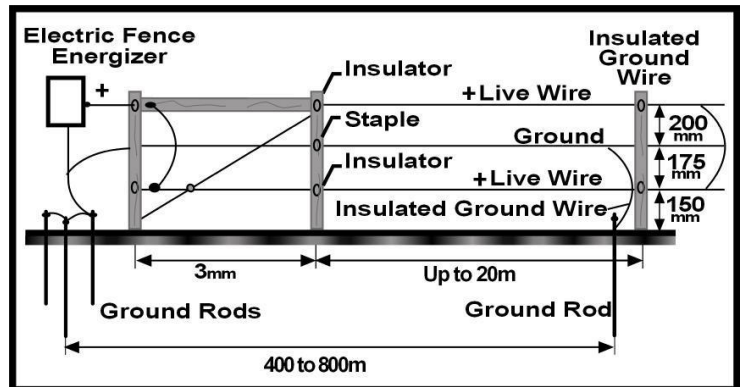
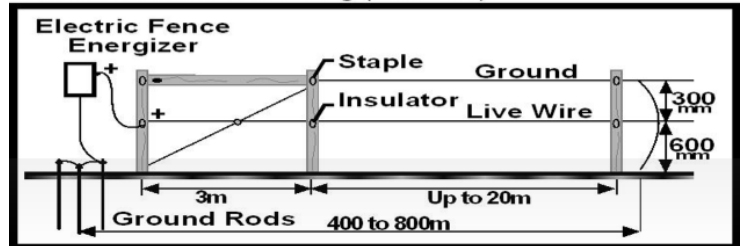

# Livestock Handling Facilities

When designing your handling system ensure that it meets the following criteria:

- Labour efficient;
- Cost effective;
- Minimizes animal stress and maximizes animal psychology;
- Safe for all users.

## Animal Psychology

- Handling facilities should be located in surroundings familiar to the animals;
- Grazing animals view life on a horizontal plane. They will try to jump any horizontal object such as rails, but will not attempt to cross vertical objects. Concrete mesh, which has a strong vertical element, has been used successfully as a perimeter fence for large corral areas;
- Sheep and cattle follow the leader so a tame lead animal is very helpful;
- Avoid the use of clubs, yelling or other physical abuse.

## Moving Animals on Pasture

- Back and forward movements behind the point of balance will move the animals forward;
- The flight zone boundary changes with the area;
- Animals that are offered new pasture often move easily;
- Always try to entice them to come; bang a pail, have a special cattle call or cow bell, etc.

## Animal Flight Zones

- Animals have excellent peripheral vision so you need to be at the mid-point to move them;
- As shown in the diagram, you control the animal movements by positioning yourself between points A and B (stop and go);
- If you place yourself behind the animals they will just turn around and look at you.

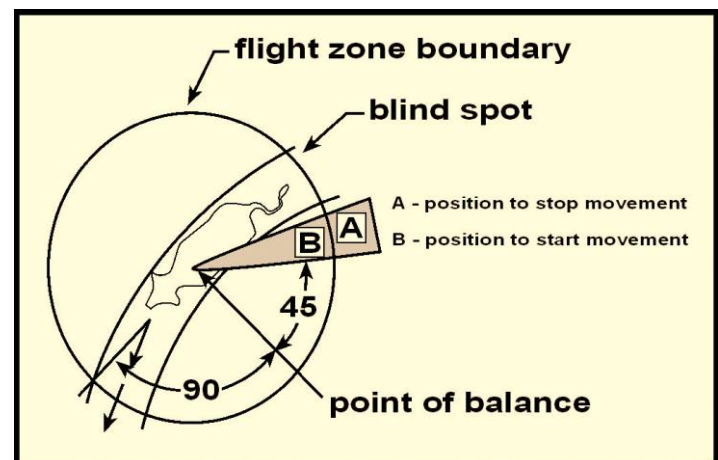
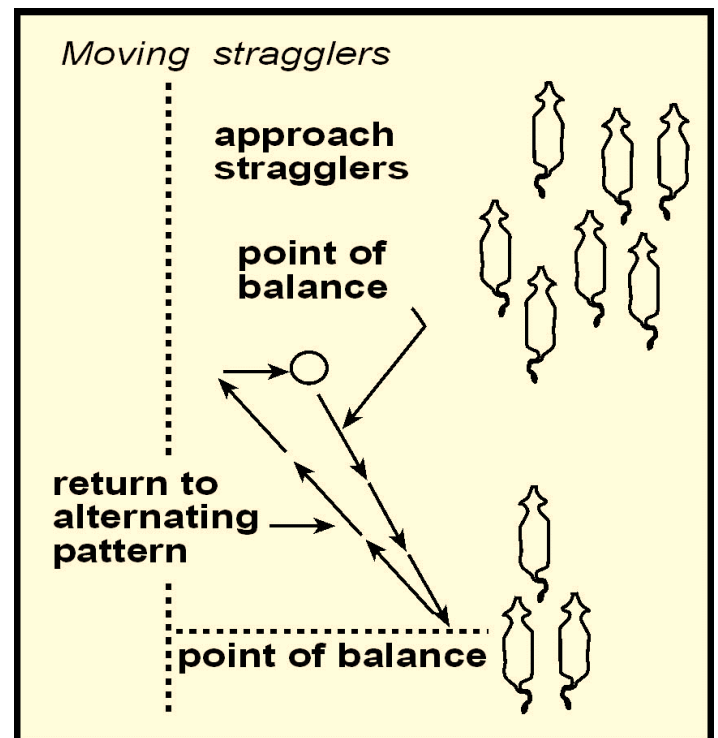

## Moving in a corral

Rapid movements in the flight zone will encourage the stock to move ahead. Flight zone boundaries will change.

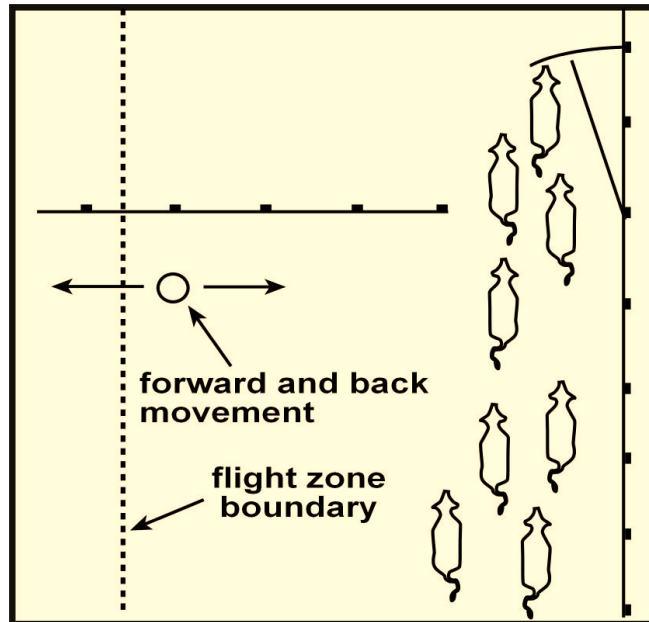

## Emptying a corral

Take the time to learn the flight zones.

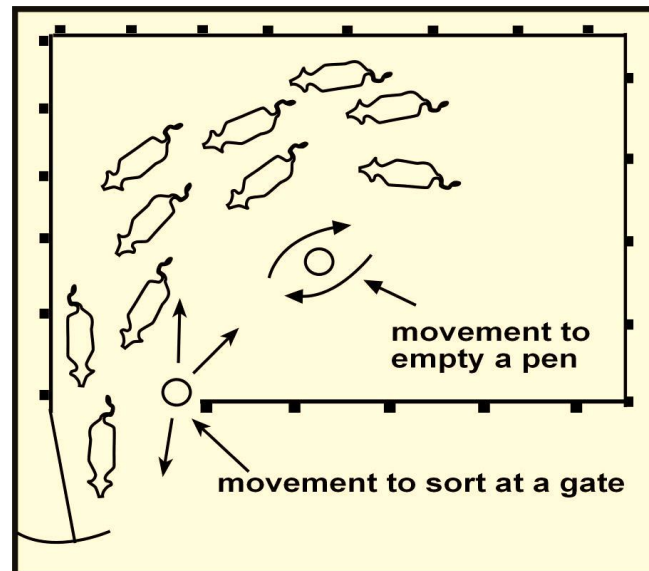

## Chute Systems

Solid sides blocks vision. Walls made of strong, solid materials such as wood, steel, or welded pipes, block the animal's vision and keep them moving;

- Curved chutes keep cattle moving as they cannot see beyond the next animal;
- Self-locking head gates make for easier cattle handling—usually at a reasonable cost.

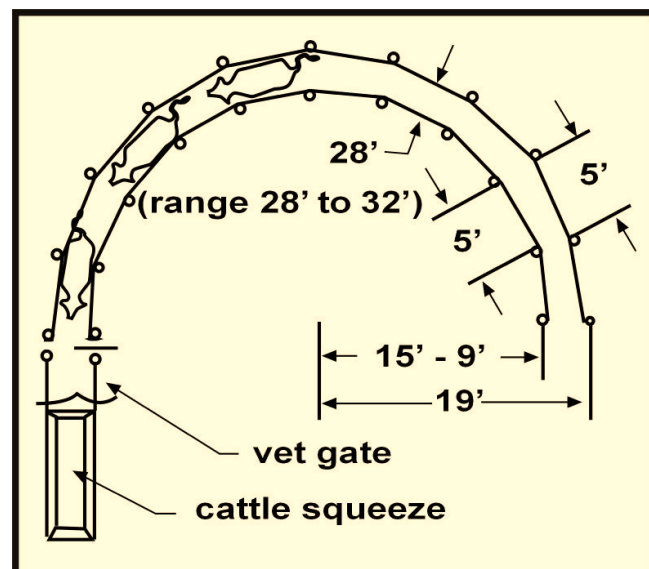

## Crowding pens

- Require a strong gate to move the animals;
- Light weight gates are very dangerous with large animals;
- Funnel the areas, don't angle both sides;
- Include a man-gate for safe and easy access;
- Match the number of animals to the size of the pen; i.e. for holding and crowding have approximately 9–18 square feet per head and for confinement, approximately 140-180 square feet per head for cattle, 5 square feet for crowding sheep.

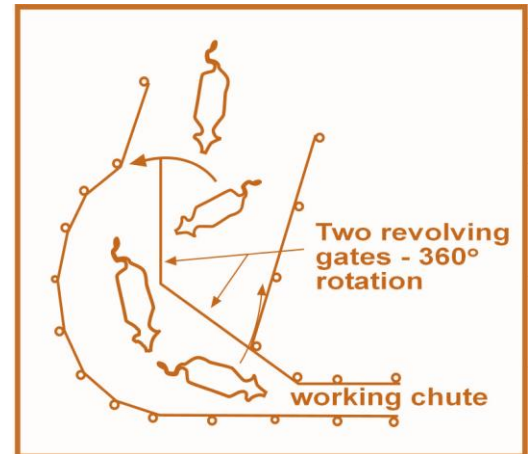
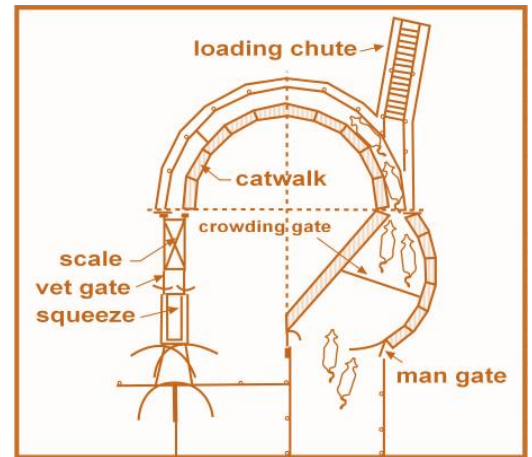
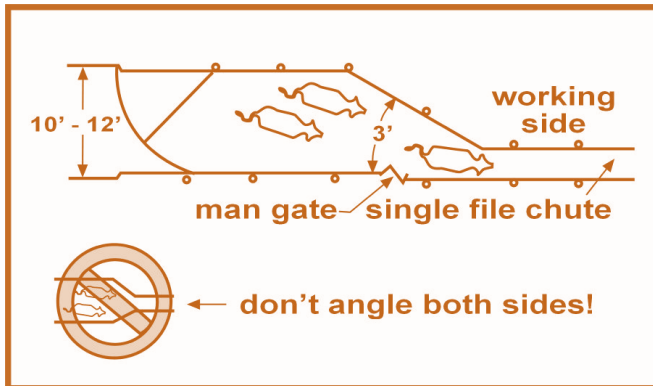

## Example of a Corral for an Eight-Paddock System

- Access to all paddocks is gained through steel panel gates;
- The central water facility can be adjusted to herd size;
- A wing gate is included to catch cattle that require treatment;
- The size is based on 40 – 50 square feet per animal;
- Low cost concrete mesh is used for sides to prevent animal jumping;
- Holding area is made out of steel pipe for safety and reliability;
- The chute is constructed from steel pipes covered with recycled metal.

**This facility can accommodate 500 head and can be adjusted to suit smaller numbers.**

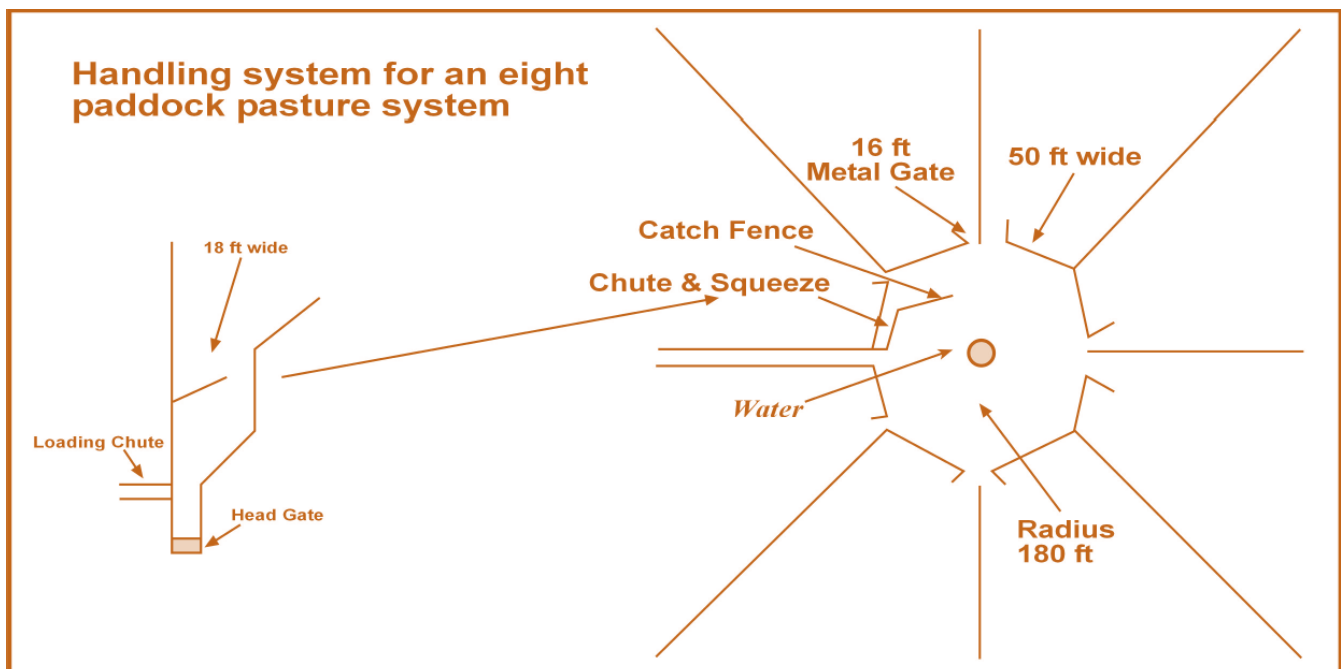

# Watering Systems

Water is essential. Without an adequate supply of quality water, animal health, weight gain, or milk production will be negatively affected.

Livestock water consumption is subject to several factors:

- Size and type of animal—sheep require 30 to 50% less water than cattle;
- Physiological state of the animal (gestation, maintenance, growing, lactating);
- Type of diet—lush forages reduce water needs, dry or mature forages increase water consumption;
- Temperature—if the temperature is above 27°C or 81°F, water consumption will double;
- Water quality—contaminants can greatly impact animal performance and herd health;
- High salt levels increase water consumption.

## Guidelines for Stock Water Requirements (Stockman’s Guide to Range Livestock Watering)

Livestock	Winter		Summer	
	Gal/day	Litres/day	Gal/day	Litres/day
Milking cows	17	77	21	<b>95</b>
Cow/calf pairs	11	50	15	<b>68</b>
Dry cows	8	36	12	<b>55</b>
Calves	5	23	8	<b>36</b>
Growing cattle (400-800lbs)	5-8	23-36	8-12	<b>36-55</b>
Finishing cattle (600-1200lbs)	12	55	19	<b>86</b>
Bulls	8	36	12	<b>55</b>
Horses	8	36	12	<b>55</b>
Sheep	<b>0.8</b>	<b>3.6</b>	<b>3</b>	<b>14</b>

Drinking facilities should be available to livestock in each paddock, preferably within 656-903 feet (200-275 metres) of the water source. In systems where livestock must travel long distances to water, forages tend to be over utilized near the water, and underutilized in areas of the paddock that are farthest from the water.

Other problems associated with this situation include uneven manure distribution in the paddock and diminished animal performance. Try to have water in the paddocks instead of having alleys to the water (typically, 15 to 20% of the manure will be dropped in the alleys and cows will drink 15% more water if the water is in the paddock).

### Points to consider:

- ✓ Are there seasonal changes to the water supply?
- ✓ If water has to be hauled to livestock, how much storage is available?
- ✓ Is there a source of electricity nearby or will other options have to be sourced?
- ✓ Are existing water sources accessible to a pumping system that does not require electricity?



## Water Source Options

### Grazed Forage

Fresh pasture is primarily water, therefore cattle on lush pastures may only consume 5 gallons per day and even less on rainy days. Spring forage growth may be only 5-10% dry matter; and mature forage may be 30% dry matter.

### Dugouts

- Used where ground water is of poor quality or inconsistent;
- Recharge from surface water such as snow or field drainage;
- Require restricted animal access to maintain water quality;
- May require aquatic weed (algae) control to reduce toxic compounds.

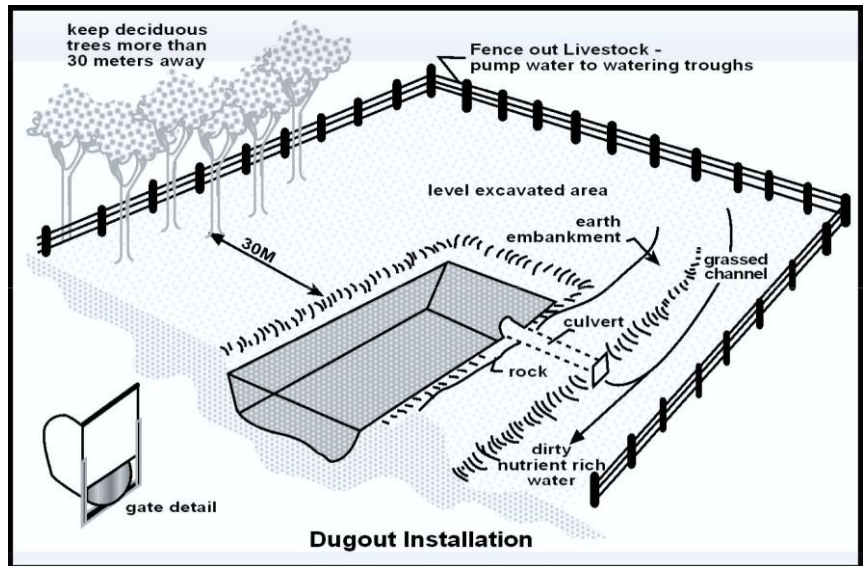

Whatever water source you choose, it must be reliable.

### Limited Access Alleyway

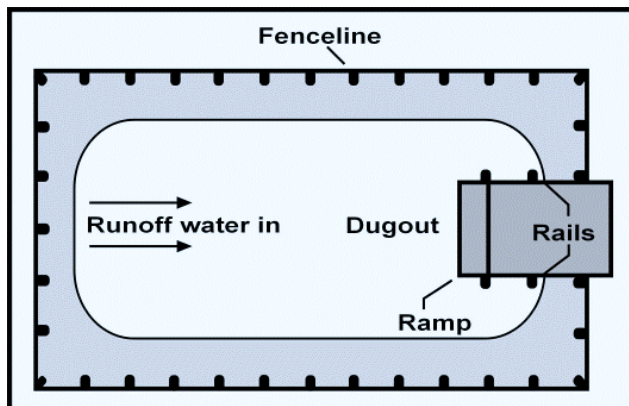
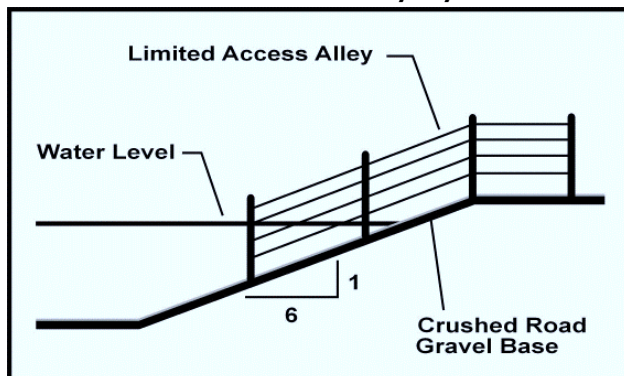

### Streams or Ditches

- Direct watering from streams or ditches will result in poor water quality, the destruction of riverbanks, the aquatic life and the ecosystem. To minimize the negative impact, pump the water into storage tanks or troughs or limit access to the water using the method outlined above.

### Groundwater – Wells or Springs

- This is the preferred water source because it provides the cleanest water;
- The recharge rate should be determined at the onset. A slow recharge rate means you must water less livestock or you must provide an alternate water supply.

### Snow

- Animals will consume less water if they eat snow covered feed;
- Cattle that consume hay on winter pasture can learn to eat snow to meet their water needs; research has shown that cattle can be successfully watered with snow in a Canadian climate;
- Wet snow is a better water source than dry snow or snow with ice.

### Moving the Water

Cattle travel to the water source approximately once per day during winter. In the summer, however, they travel between 5 and 7 times per day. The further the distance they have to travel, the longer they will remain at the water source. Ideally, the total herd should be able to drink in less than one hour, even at the highest demand.

Cattle like to remain as a herd, but if they can maintain eye contact with each other, they will travel alone. Individual watering reduces the pressure on both the water source and the land. A central watering paddock can be used for adjoining paddocks. The watering area should be small enough to discourage animals from lounging nearby. This system works for 2 to 4 paddocks, however, any more will result in trampling of the forage at the site.

## Pumps

### Electric and Gas Pumps

- Automated electric pumps are generally the most reliable;
- A ¾ HP pump will maintain pressure in a 1.5 inch water line;
- Gas pumps are used to fill storage tanks in remote locations. They either have an automatic cut-off switch, or are left to run out of gas;
- Nose pumps on pasture usually require one pump for 25 to 30 cow/calf pairs depending on the distance to the water. The pumps can lift water approximately 20 feet.

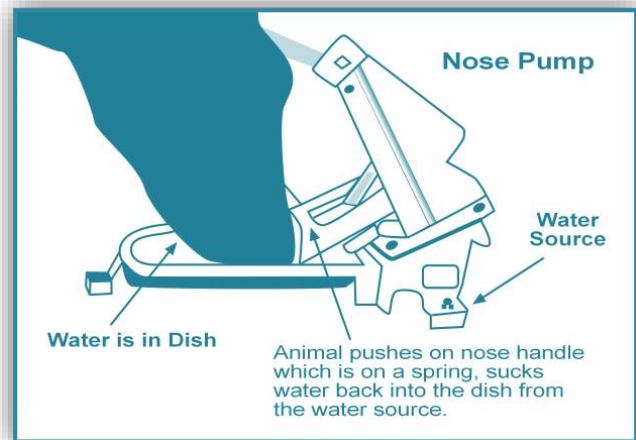

### Solar Pumps

- A good choice for remote locations;
- They must be checked every 3 days and have a stand-by generator or a gas pump for extended cloudy weather;
- It is best to use a large trough/container and run the pump less frequently;
- The deep-cycle battery must be stored in an insulated container to protect it from cold weather;
- Voltage metres and battery testers are essential.

## Water Lines

- A water line is often the most economic system for moving water;
- Water delivery is limited by the size of the pipe and the number of inserts within. The optimal pipe size is 1.5 inches in diameter to minimize friction;
- 75 psi quality pipe withstands some freezing, but it is best to blow out the water lines in fall;
- All pipeline should be buried at least 8 inches deep. This provides some frost protection and extends water delivery until late fall. Pipeline plows for burying your water lines are available for rent in some Alberta communities.

Pipe Sizing Guide (liters/minute)			
Pipe Width	Pipe Length (meters)		
cm/inche	30m	166m	500m
<b>1.3/.5</b>	18	9	5
<b>2.5/1.0</b>	58	36	22
<b>3.2/1.5</b>	103	85	40

## Trough Space

- Allow 5–10% of the herd to drink at one time. Each animal will drink 5–10 gallons per event;
- Rule of Thumb: allow 1.5 inches of space between animals around the trough. A herd of 100 requires 12.5 feet of tank rim space. This will allow 8 animals to drink at the same time for 4 minutes and the herd will be watered in 60 minutes.

## Tank and Trough Options

### Troughs

- Commercial galvanized troughs can be abused by stock. They must be comprised of strong steel;
- Fiberglass units are strong and difficult for stock to abuse. These units are readily available in 1,000 gallon plus capacities.

### Poly Tank Watering System



Diagram of a poly tank watering system

### Watering System

- 1) Poly tank is a used fertilizer tank
- 2) The output valve is tied to a float that closes when the tank is full and opens when the water level drops. The output valve opening must be the same diameter as the tank hose to maximize recharging when the animals are drinking
- 3) Railroad ties are used to elevate the tank

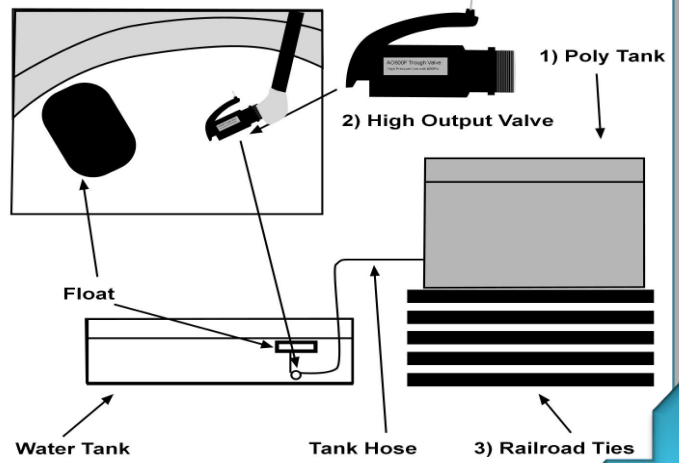

### Grain Bins

- Galvanized steel rings from grain bins are often used for large watering sites;
- Concrete is used to form a water seal base. One can also use a plastic or fiberglass liner with a solid base of sand (smooth surface for liner) with a geo-textile liner below to hold the sand in place;
- A rail is required to prevent the animals from jumping into the tank and making holes in the liner.



19 foot grain bin = 4,000 gallons



### Machinery Tires

- Large machinery tires can also be used as water troughs. They are almost indestructible;
- Cut back the upper bead 5 to 6 inches using a reciprocating saw;
- Use a concrete pad and seal with an epoxy sealant.

# Remote Locations

Water can be trucked out to the herd in large tanks. High output valves will supply the water at a high discharge rate.

## Remote Winter Watering

Technical advances in the use of natural energy sources such as geothermal heat and solar and wind power allow producers to water cattle at remote locations. Examples of remote winter water systems are:

### Motion Detector Water Pump up System

When an animal walks up to the drinking bowl, an electronic motion detector turns on a pump that fills the bowl with water. When the animal leaves the detection area, the pump shuts off and the water drains back down through the pump so no water is left exposed to the cold. A filter prevents hay and debris from going back down into the pump with the water. The pump is powered by a solar DC battery.

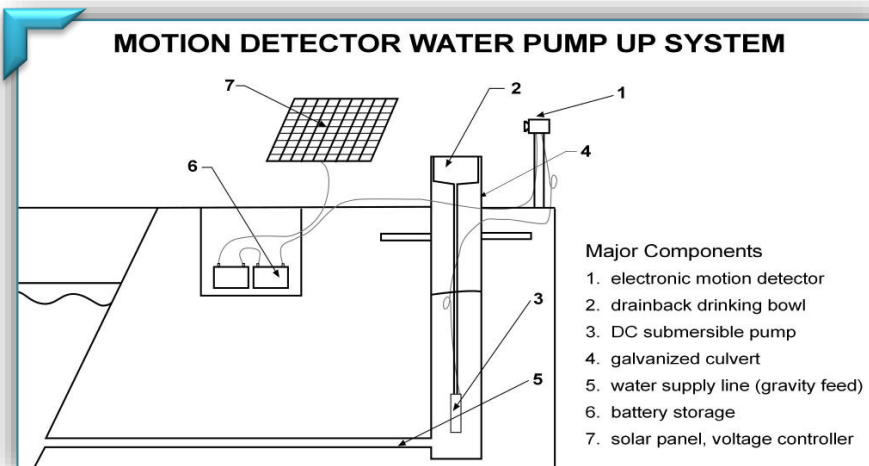

- Water must be within 15 feet of the surface. If it must be pumped from further away, it will require two pumps and more than one DC power supply.
- Filter must be cleaned frequently.
- DC batteries must be protected from the cold. A discarded household chest freezer is an excellent battery storage compartment.

### Portable Ice-Free Waterer (Using a well-insulated building)

A small, highly insulated, portable building encloses a poly tank that holds hundreds of gallons of water, several degrees above freezing. The cattle drink from a water trough which only has a small area situated outside of the building. The building temperature is moderated by the latent heat of the hundreds of gallons of water stored within the building.

- The building must be well insulated. It should have enough cattle drinking so that at least 300 gallons of water are consumed and replaced daily. If all water is consumed and exchanged with new water, it will cool and the system will begin to freeze.
- Some ice may need to be cleared from the drinking tubes on the coldest days.
- Batteries and/or gas powered generators do not freeze when housed in the building.

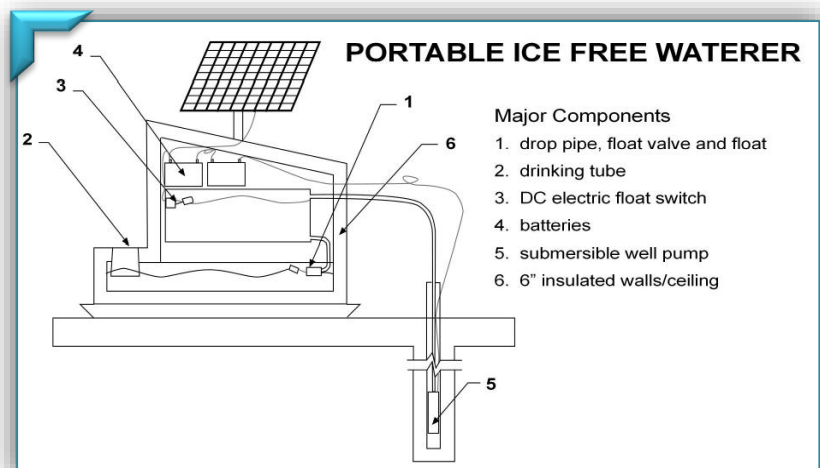

## Mining Tire Geothermal Waterer

Cattle drink from a water trough made from a used industrial mining tires. The bottom side of the drinking water trough is kept relatively warm with geothermal heat rising from below the frost line.

Water is provided through a buried supply line from an existing water source. The tire pit below ground level allows for geothermal heat to rise, which keeps the supply line from freezing and keeps the drinking trough warm. This works best with very thick rubber tire faces.

- Mining tire will generally have a layer of ice each morning, which must be cleared. Once cleared the cattle keep it free the remainder of the day.
- There must be enough cattle drinking from the trough to completely replace all the water every day, or the water will get colder and eventually freeze solid. Not suitable for small herds.
- Well suited for deep burial pipelines that travel great distances underground.

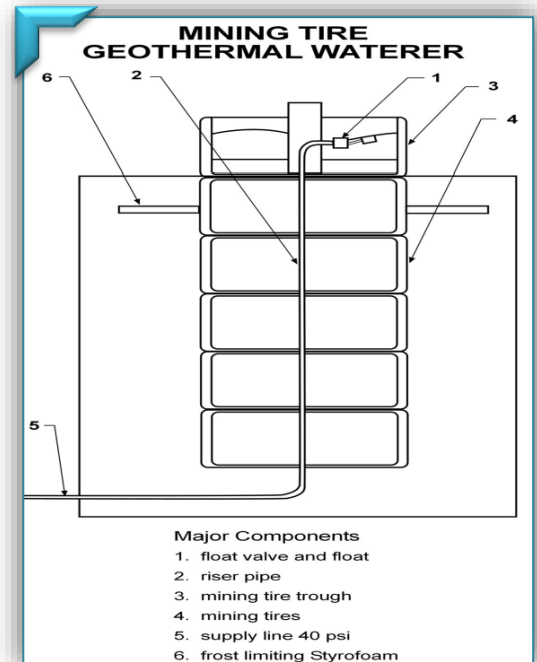

## Geothermal Ice Free Waterer

Cattle drink out of the top of an insulated galvanized tube that contains about 500 gallons (2,300 litres) of water. The water is kept warm from geothermal heat and the latent heat contained within the water itself.

- Cattle drink directly out of a drinking tube located at the top of the four foot diameter insulated galvanized culvert. The culvert is 10 feet tall with eight feet below ground level. The latent warmth of the water keeps the small diameter drinking tube free of ice even in cold weather. The water supply pipe enters the bottom of the culvert below the frost line, and comes up the middle of the culvert to be controlled with a float valve under an insulated lid. A float valve is used to ensure the water height is set within three to five inches of the top of the culvert.

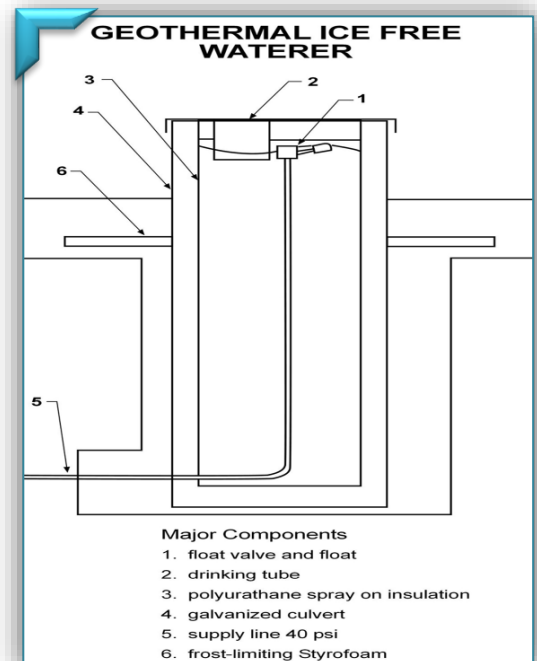

- In exceptionally cold weather, the drinking tube may develop an ice plug in the drinking hole that must be cleared. This may occur a few days each winter.
- Works well with minimal management and with long-run underground water supply pipe lines.
- No electricity required, may be adapted to DC powered deep well pumps and drilled well situations.

# Extended Grazing

Extended grazing involves expanding the grazing season beyond the traditional summer grazing period to late fall or in some cases throughout the winter. Various methods are employed to ensure that both the livestock and pasture health is maintained or improved. The following points illustrate just how beneficial this system is.

- ✓ Reduces daily feeding costs by as much as 48% (*BCRC, December 2012*)
- ✓ Animal harvests its own feed so less machinery is required;
- ✓ Manure is deposited on the land so there is less manure handling.
- ✓ Better use of the forage feed available on the farm
- ✓ Stockpiled forage can be used;
- ✓ Crop residues from cereal crops can be utilized;
- ✓ Forage available on the headlands; low non-crop areas can be used.
- ✓ Environmental benefits
- ✓ Less concentration of animals in one location (feedlot);
- ✓ Manure is spread over areas where it might be difficult to spread mechanically;
- ✓ Manure provides fertilizer for the forages;
- ✓ Potential to increase plant diversity as seeds from feed hay can be re-seeded in the feeding area.

## Options for Stockpiling Forage

- Stockpile perennial forage by saving the second growth from the pasture for use in the fall after the first killing frost or in spring before the spring growth;
- Choose forages that stand tall in snow such as tall fescue or Russian wild rye grasses. Soft grasses such as orchard or meadow brome do not stay erect in snow, and alfalfa loses leaves and is lower in quality after frost;
- Harvest the first cut of the paddocks you choose to stockpile, or graze after mid-July, then graze again in November/December;
- Estimate dry matter yield by forage height – the following chart indicates average figures, however, it is best to measure your own pasture using a falling plate meter;
- You need to have an estimate of the forage available in order to plan for the volume you'll need for the fall and winter grazing.

## Seeded Annuals

- Can be used to bridge the summer grazing slump that usually occurs during hot weather;
- Can be used as stockpiled forage or for swath grazing in the non-growing portion of the year;
- Compare the cost of seeded annuals versus perennials prior to seeding.

*WCFA Swath Grazing Demonstration Project:*  
<http://www.westcentralforage.com/projects.aspx>

## Pasture Productivity Chart

Forage	Fair	Good	Excellent
—lb/acre for each inch of grass height--			
Mixed Pasture	150-250	250-350	350-450
Orchardgrass & Legumes	100-200	200-300	300-400
Bluegrass & white clover	150-250	300-400	500-700
Smooth Brome grass & Legumes	150-250	250-350	350-450
Red Clover Or Alfalfa	150-200	200-250	250-300
Tall Fescue & Legumes	200-300	300-400	400-500

## Bale Grazing

- Reduces the labour and equipment costs that are associated with manure removal;



- Bales should be set out in rows across the selected field for winter

grazing/feeding;

- The bales should be spaced at least
- 20 feet apart for easy access by animals; further spacing may be required to manage nutrient loading in the soil. Consult your local government office for manure/ nutrient application regulations;
- Electric temporary fencing can be used to protect the bales not being used;
- Twine should be removed when setting the bales out in fall.
- The Bale Grazing Calculator© is a tool to help producers estimate the cost of feeding livestock with bale grazing. <http://publications.gov.sk.ca/redirect.cfm?p=75821&i=84795>

## Crop Residues

- Animals must receive supplements when they are fed crop residues.

## Swath grazing

- Swath grazing is the practice of allowing livestock to graze annual cereals in the swath during the winter months.
- Research indicates that swath grazing can reduce total daily feeding cost per cow by 41 to 48%. This is based on a 78% reduction in yardage costs and a 25% reduction in feed costs. Daily feed costs range from \$0.61 to \$1.80 per cow, largely due to variability in the number of grazing days per acre.
- Swath grazing usually begins in November, and can continue until a couple of weeks before calving, i.e.: April or May.
- Cattle should be allocated enough swath area so that they clean up the area in about 2 to 3 days.

- An electric fence can be used to contain the area. Adequate shelter must be provided and an alternative water source is necessary in case the cows are unable to use snow for their water requirements. It is also advised to provide a bedded area for the cows. Cows will rest on the swaths, but providing bedding will reduce residual wastage in the swaths do to cow dung.
- After calving, cows and newborn calves can return to swath grazing fields if the area is dry. Cows with nursing calves will need extra energy in the form of grain or hay to meet their nutritional requirements.



## Winter Feeding on Pasture

- Livestock can be wintered away from the yard-site and corrals for all or part of the winter season;
- The feeding and windbreak location should be moved on a regular basis so the nutrients from the manure and urine are spread over a large area;
- Manure can be concentrated over areas where soil fertility is poor;
- Livestock can be fed on virtually any parcel of land you choose, provided there is water or adequate snow available for the stock. Research has shown that cattle that utilize snow perform as well as those on water;
- The amount of hay hauling can be reduced if the grazing is located close to where it was baled;
- Fall and winter grazing practices such as stockpiling perennial forage, swath grazing, and crop residue grazing, can be used on open parcels of land that do not have natural or other man-made shelters;
- Portable wind-breaks can be moved when snow accumulates thereby eliminating the need for snow removal.
- Moving the site on a regular basis reduces diseases on calving ground.

# Pasture Assessment

A healthy pasture is a productive pasture. Several factors must work together to create the ideal environment for plant growth. By assessing your pastures annually, you can measure the health of the pasture, set management goals, and identify improvements. The initial assessment becomes your benchmark by which you measure the impact of changes such as stocking rates, length of grazing, and length of rest period. Tame pasture and native pasture vary only in the diversity of the plants.

*Pasture assessment examples and worksheets are in the following chapter.*

## Tame Pasture Assessment

The planted species should be the dominant plant in the paddock. There should be very few invader species such as Kentucky bluegrass or Canada thistle. When these common invaders are present they limit productivity since they compete for available water and nutrients.

The density of the plant population is an indication of the health of the pasture. There should be adequate space so the plant leaves can spread out and undergo photosynthesis. The greater the leaf area of the plant, the greater the incidence of photosynthesis and resulting plant growth. Too much space encourages invaders.



Managing mulch (vegetation residue) is the key to long-term pasture health and productivity. Mulch decreases soil erosion, reduces soil temperature

and evaporation, improves water infiltration, and increases forage production. The use of mulch can buffer the impact of drought. A continuous layer of mulch, approximately 1/2 an inch is ideal. An absence of mulch is an indication of overgrazing.

## Native Pasture Assessment

The desired native species should be present and dominant. Over the past



10,000 years, several prairie native grasses have adapted to our climate and are excellent producers. Western wheat grass, grama grasses, green needlegrass and Indian grass all have exceptional yields, even in the face of

drought.

Biodiversity is the key to native prairie resilience. A mixture of legumes and grasses are a sign of good pasture health. Legumes are known for their ability to utilize the nitrogen in the atmosphere to help the plant grow. When the plant dies, it leaves nitrogen in the soil for other plants to use.

As with tame pastures, the density of the plants and the available mulch are important factors for optimum production.



Capitalize on forage production by maximizing ground covered with productive, adapted forage plants.



# Examples and Worksheets

The following pages provide an example of the costs associated with the establishment of a pasture. Worksheets are provided to help you determine your actual costs. To download an interactive worksheet where you can input your figures and have the calculations done for you go to: [www.mbforagecouncil.mb.ca/grazingclubs](http://www.mbforagecouncil.mb.ca/grazingclubs)

*Sketch your existing and revised forage plan below (example on page 6).*

- Legend:
-  Two-wire permanent fence
  -  Single wire permanent fence
  -  Temporary, moveable fencing



**Existing Pasture (Forage) Plan**



**Revised Pasture (Forage) Plan**

Use this chart to select forages for your pasture plan.

Annual forages for extended grazing			Forage species end use		
Crop	Seeding Dates	When to Graze	Forage Species	Rotational Grazing	Stored Feed
Oats	May 1-June 1	Pre-boot stage	Meadow brome	●	●
Barley	May 1-31	Pre-boot stage	Smooth brome	◇	●
Wheat	May 1-31	Pre-boot stage	Hybrid brome	●	●
Winter wheat-spring seeded	May 1-31	15-20 cm	Meadow foxtail	●	◇
Winter wheat fall seeded	Aug 1-Sep 15	Fall grazing 15-20 cm, spring grazing, pre-boot stage	Creeping red fescue	●	◇
Fall Rye-spring seeded	May 1-31	15-20 cm	Tall fescue	●	●
Fall Rye-fall seeded	Aug 1-Sep 15	Fall grazing 15-20 cm, spring grazing, pre-boot stage	Kentucky bluegrass	●	◇
Corn	May 1-25	Fall or winter	Orchard grass	●	●
Siberian millet	May 25-Jul 10	Can be grazed, but usually used for hay/silage	Reed canarygrass	◇	●
Proso millet	May 15-Jul 10	Can be grazed, but usually used for hay/silage	Annual ryegrass	●	◇
Ryegrass (Italian)	Apr 10-June 1	10-15 cm	Timothy	◇	●
Ryegrass (Westerwold)	Apr 10-Jun 1	Graze 10-15 cm, hay early flowering, 5-6 wks after seeding	Crested wheatgrass	●	◇
Intercropping winter cereal & fall rye	Apr 10-Jun 1	Harvest 1st cut (cereal) at boot stage and graze fall rye mid summer	Intermediate wheatgrass	◇	●
Swath grazed crops	June 15-30	Swath prior to early dough stage, graze in late August (non-growing portion of the season)	Pubescent wheatgrass	◇	●
			Russian wildrye	●	◇
			Alfalfa	◇	●
			Cicer milkvetch	●	◇
			Red clover	◇	●
			White clover	◇	◇
			Alsike clover	●	●
			Sweet clover	◇	●
			Kura clover	◇	◇
			Sainfoin	◇	●
			● Highly suited to end use	◇ Less suitable use	

# Forage Establishment Costs

The following example outlines the costs associated with a 320 acre pasture. Use the worksheets on the next two pages or download an excel spreadsheet at [www.mbforagecouncil.mb.ca/grazingclubs](http://www.mbforagecouncil.mb.ca/grazingclubs) to input your own information.

Forage Establishment Example for 320 Acres							
1: Forage Species		lbs./ac	Total lbs.	Seeds per ft.	Cost/lb.	Cost/acre	Total
alfalfa		1.0	320	5	\$ 1.80	\$1.80	\$ 576.00
trefoil		1	320	9	\$ 1.75	\$1.75	\$ 560.00
timothy		0	0	0	\$ 1.25	0	\$ -
meadow brome		5	106	9	\$ 3.95	\$19.75	\$ 6,320.00
tall fescue		3	960	16	\$ 2.50	\$7.50	\$ 2,400.00
creeping red fescue		0		0	\$ 1.75	0	\$ -
reed canary		0	0	0	\$ 3.06	0	\$ -
orchard		0	0	0	\$ 2.75	0	\$ -
<b>Total</b>		<b>10</b>	<b>3,200</b>	<b>38</b>	<b>\$ 18.81</b>	<b>\$30.80</b>	<b>\$ 9,856.00</b>
(25-35 seeds/sq. ft. is ideal - allow higher rates if poor seed bed conditions exist)							
2. Cover Crop		lbs/ac	Total lbs.	Seeds per ft.	Cost/lb.	Cost/acre	Total
Oats		40	12,800		\$ 0.11		\$ 1,408.00
Annual rye grass		6	1,920		\$ 1.00		\$ 1,920.00
Custom Seeding						\$3.50	\$1,120.00
<b>Total</b>					<b>\$ 3,328.00</b>		
3. Fertility		Nitrogen	Phos.	Potassium	Sulfur		Total
	lbs./ac	0	40	0	0		
	cost/lb.	\$ 0.70	\$ 0.66	\$ -	\$ -		\$ 8,448.00
4. Weed Control						Cost/acre	Total
Herbicides						\$ -	\$ -
5. Other Establishment costs						Cost/acre	Total
						\$ -	\$ -
6. Total capital cost						Cost/acre	Total
Forage seeding						\$30.80	9,856.00
Cover crop						\$10.40	328.00
Fertility						\$26.40	8,448.00
Weed Control						-	-
Other establishment costs						-	-
<b>Total</b>						<b>\$ 67.60</b>	<b>\$ 21,632.00</b>
7. Annual Cost							Total
Establishment costs to be recovered in 6 years							
Annual principle							\$3,605.33
Annual interest 8.0%							\$288.43
<b>Total annual cost</b>							<b>\$3,893.76</b>
<b>Annual cost/acre</b>							<b>\$12.17</b>

The following worksheets can be used to determine your annual forage costs or you can download this interactive worksheet at: [www.mbforagecouncil.mb.ca/grazingclubs](http://www.mbforagecouncil.mb.ca/grazingclubs)

### Worksheet #1

Forage Establishment Worksheet (____) Acres							
<b>1: Forage Species</b>		<b>lbs./ac</b>	<b>Total lbs.</b>	<b>Seeds per ft.</b>	<b>Cost/lb.</b>	<b>Cost/acre</b>	<b>Total</b>
<b>Total</b>							
(25-35 seeds/sq. ft. is ideal - allow higher rates if poor seed bed conditions exist)							
<b>2. Cover Crop</b>		<b>lbs/ac</b>	<b>Total lbs.</b>	<b>Seeds per ft.</b>	<b>Cost/lb.</b>	<b>Cost/acre</b>	<b>Total</b>
Custom Seeding							
<b>Total</b>							
<b>3. Fertility</b>		<b>Nitrogen</b>	<b>Phos.</b>	<b>Potassium</b>	<b>Sulfur</b>		<b>Total</b>
	lbs./ac						
	cost/lb.						
<b>4. Weed Control</b>						<b>Cost/acre</b>	<b>Total</b>
Herbicides							
<b>5. Other Establishment costs</b>						<b>Cost/acre</b>	<b>Total</b>
<b>6. Total capital costs</b>						<b>Cost/acre</b>	<b>Total</b>
Forage seeding							
Cover crop							
Fertility							
Weed Control							
Other establishment costs							
<b>Total</b>							
<b>7. Annual Costs</b>							<b>Total</b>
Establishment costs to be recovered in ____ years							
Annual principle							
Annual interest ____%							
<b>Total annual cost</b>							
<b>Annual cost/acre</b>							

**Worksheet #2**

Forage Establishment Worksheet (___) Acres							
<b>1: Forage Species</b>		<b>lbs./ac</b>	<b>Total lbs.</b>	<b>Seeds per ft.</b>	<b>Cost/lb.</b>	<b>Cost/acre</b>	<b>Total</b>
<b>Total</b>							
(25-35 seeds/sq. ft. is ideal - allow higher rates if poor seed bed conditions exist)							
<b>2. Cover Crop</b>		<b>lbs/ac</b>	<b>Total lbs.</b>	<b>Seeds per ft.</b>	<b>Cost/lb.</b>	<b>Cost/acre</b>	<b>Total</b>
Custom Seeding							
<b>Total</b>							
<b>3. Fertility</b>		<b>Nitrogen</b>	<b>Phos.</b>	<b>Potassium</b>	<b>Sulfur</b>		<b>Total</b>
	lbs./ac						
	cost/lb.						
<b>4. Weed Control</b>						<b>Cost/acre</b>	<b>Total</b>
Herbicides							
<b>5. Other Establishment costs</b>						<b>Cost/acre</b>	<b>Total</b>
<b>6. Total capital costs</b>						<b>Cost/acre</b>	<b>Total</b>
Forage seeding							
Cover crop							
Fertility							
Weed Control							
Other establishment costs							
<b>Total</b>							
<b>7. Annual Costs</b>							<b>Total</b>
Establishment costs to be recovered in ___ years							
Annual principle							
Annual interest ___%							
<b>Total annual cost</b>							
<b>Annual cost/acre</b>							

## Determining Pasture Condition

The intent of using the *AB Tame Pasture Scorecard* is to provide grazers with a pasture evaluation method to determine if their paddocks are in need of improvement. It is also a useful tool in evaluating the impact of management decisions on pastures. Copies of the *AB Tame Pasture Scorecard* can be ordered by calling 310-FARM.

### What is the Alberta Tame Pasture Scorecard?

- The *Tame Pasture Scorecard* is a simple, non-technical method to visually assess pastures.
- It uses farm level indicators and descriptions to describe pasture health and productivity. Healthy, productive pastures maintain and protect soil and water resources, provide sustainable grazing, and require fewer inputs.
- The *Tame Pasture Scorecard* allows tame pastures to be assessed without the use of technical equipment.
- It is a tool to raise awareness of pasture management and increase the working knowledge of pastures.

### Why Should I Use the Alberta Tame Pasture Scorecard?

- Pasture assessment is important to optimize pasture performance and evaluate the sustainability of pasture management systems.
- Regular use allows assessment of current pasture performance, records changes in performance over time, identifies potential problem areas, and provides a measure to compare fields and management practices.
- The *Tame Pasture Scorecard* can be used to make informed management decisions.

### How Do I Use the Alberta Tame Pasture Scorecard?

**Step 1)** All you need to complete the assessment is a pencil and a scorecard. (A pasture measuring stick can also be used to assess production.)

**Step 2)** Assess tame pastures during the growing season.

**Step 3)** Divide the farm or fields into separate sections for assessment based on management practices, soil type, or topography.

**Step 4)** Complete the field identification and management notes section with information regarding the field or area being assessed.

**Step 5)** Rate each indicator based on your judgment of the pasture and circle the ranking that best describes the pasture condition. For example, when asked for a "%," make your best visual estimate. Include other indicators that you think would help evaluate your pasture.

**Step 6)** Follow changes in each of the indicators over time. Note those indicators that need improvement and consider management options that might improve the pasture in those areas.

#### Note:

- ✓ Assessments are qualitative and subjective. They are most effective when consistently completed by the same person over time, under similar field conditions, and at the same time each year.
- ✓ Assess more than one spot in a field to obtain more accurate results. Do at least three assessments per pasture, more if the field is variable.
- ✓ Avoid areas near water, trees, or other areas where animal impact is concentrated when assessing the field. You may want to assess these areas separately.
- ✓ The scoring of indicators does not represent an absolute measure or value. Its purpose is to assess the ability of each pasture to function within its environment.

## How can I improve my Tame Pasture?

### Plant population

Desirable plant species vary with site, grazing animal, and intended use. Encourage productive, well-adapted plant species by controlling overgrazing and patch grazing with cross fencing, increasing rest periods during the growing season, varying timing of grazing, and managing soil fertility. If fewer than six productive plants per square foot are present, you may need to reseed.

### Plant density

Maximize forage production by maximizing ground covered by productive, adapted forage plants. Less productive plants compete for light, water, and nutrients, limiting overall forage production. Appropriate plant density varies with forage species present and environment. For example, bunch grasses will have more bare soil than creeping rooted grasses, and dry environments more bare soil than wetter environments.

### Plant vigor

Vigorous plants produce more forage. Plant crowns should have actively growing shoots to provide regrowth after grazing. Vigorous forage plants need to rest and recover from grazing during the growing season. Ensure adequate soil nutrients are present to support forage growth.

### Legumes present

Legumes fix nitrogen and contribute nitrogen to forage grasses. Thirty percent or more legumes in the forage stand may eliminate the need for nitrogen fertilizer. Manage pastures to maintain legume populations by ensuring phosphorus, potassium, and sulfur requirements are met, selecting long-lived, hardy legume species and varieties, and managing grazing periods.

### Weeds and brush present

Weeds and brush reduce forage production and restrict livestock access to forage. Managing for vigorous forage plants increases competition and may reduce brush cover. Time controlled rotational grazing may also reduce weeds and brush. However, you may also need to use herbicides in combination with grazing management to control problem brush and weeds.

### Ground cover

Appropriate litter (dead and decaying plant material) levels and soil organic matter improve the water holding capacity of soil, improve water infiltration, reduce evaporation, and return nutrients to the soil. Appropriate litter levels vary with environment, site, and plant species present. For example, bunch grasses will tend to have less litter than creeping rooted grasses. Litter from productive tame forages in higher rainfall areas breaks down rapidly in the soil. Improve ground cover by enhancing desirable plant production and vigor, allowing litter to accumulate, and winter feeding on pastures.

### Soil damage

Reduce soil damage by reducing bare soil present. Increasing plant density and vigor and increasing the litter present will reduce soil damage. Grassed waterways and managed buffer zones along streams and rivers will help reduce soil erosion. Hoof action on bare soil (especially heavier soils) when they are damp can result in soil compaction and a breakdown in soil structure, which will reduce plant growth.

### Nutrient cycling

Ensure soil nitrogen, phosphorus, potassium, and sulfur levels are adequate through fertilization, applying manure, or winter-feeding on pastures. Grazing livestock recycle large amounts of nutrients through manure and urine. Ensure nutrients are spread back onto pastures by fencing livestock out of trees, limiting loitering areas near water, and cross fencing to get more uniform distribution of manure across pastures.

### Severity and uniformity of use

Overgrazing reduces forage plant vigor and production and can lead to a reduction in desirable forage species and an increase in grazing tolerant plants. Patch grazing may result in underutilization of the forage resource. Cross fencing, rotational grazing, and ensuring water is available nearby will help you get more uniform use.

Alberta Agriculture and Forestry  
For more information, visit:  
[www.agric.gov.ab.ca](http://www.agric.gov.ab.ca)

# Alberta Tame Pasture Scorecard

Field Identification and Management Note

Field ID: \_\_\_\_\_

Assessment Date: \_\_\_\_\_ Rainfall: Normal \_\_\_ Wet \_\_\_ Dry \_\_\_

Temperature: Normal \_\_\_\_\_ Hot \_\_\_\_\_ Cool \_\_\_\_\_ Plant Species Present:

Desirable:

Less Desirable:

Problem:

Grazing System: Continuous \_\_\_\_\_ Rotational \_\_\_\_\_ Other:

Past Management:

Date(s) Animals Entered Pasture: Date(s) Animals Taken Out: Number/Type of Animals

Grazing:

Pasture Yield: \_\_\_\_\_ Pasture Size: \_\_\_\_\_

Fertilizer(s) Applied:

## Field Map

(Mark cross fences, areas of special interest and assessment points)

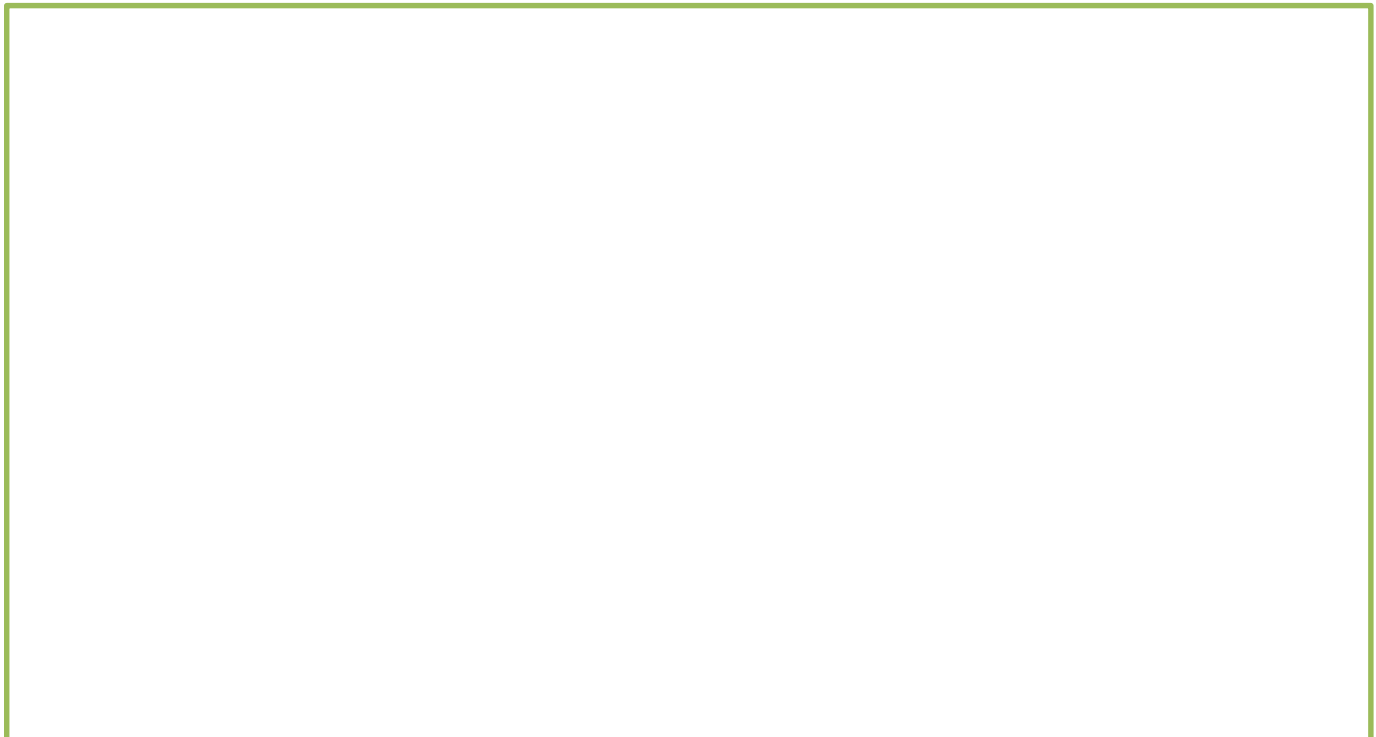

Additional Comments or Note



# Alberta Tame Pasture Scorecard

Field ID: \_\_\_\_\_ Date: \_\_\_\_\_ Name: \_\_\_\_\_

Indicator	Ranking			Score Circle One
	Low (L)	Moderate (M)	High (H)	
Plant Population	Many undesirable or low producing species present, little forage from desirable species.	Some undesirable or low producing species present, little forage from desirable species.	Mostly productive, adapted, desirable forage species present.	L M H
Plant Density	Desired plants sparse. More than 25% bare ground or undesirable species.	Desired plants moderately spaced. 5% to 25% bare ground or undesirable species.	Desired plants densely spaced. Less than 5% bare ground or undesirable species.	L M H
Plant Vigor	Poor growth of forage plants, uneven stand, light green color, slow spring growth, slow regrowth.	Some uneven growth of forage plants, inconsistent forage production, often produces less than potential.	Healthy, vigorous forage plants. Plants dark green and leafy. Uniform stand, good production, plants grow rapidly.	L M H
Legumes Present	Less than 5% of forage yield from legumes.	5% to 30% of forage yield from legumes.	More than 30% of forage yield from legumes.	L M H
Weeds and Brush Present	Weeds and/or brush cover more than 20% of area.	Weeds or brush rare, patches small, cover 10% to 20% of area.	Few to no weeds or brush, cover less than 10% of area.	L M H
Ground Cover	Growing plants sparse. Dead and decaying plant material and mulch light. Bare soil present.	Growing plants plentiful. Dead and decaying plant material patchy, moderate or excessive. Some bare soil present.	Growing plants, dead and decaying plant material and mulch adequate and evenly distributed. Little bare soil present.	L M H
Soil Damage	Obvious soil drifting, washouts or gullies present. Soil compaction and/or tramping present.	Some evidence of soil drifting, few gullies. Limited soil compaction or tramping.	No visible erosion, soil compaction or tramping.	L M H
Nutrient Cycling	Manure concentration in a few areas. Manure breaks down slowly. Forage around urine and manure patches darker green.	Some dark green forage near manure and urine patches visible. Manure fairly uniform across field, some older manure accumulation.	Manure distributed uniformly. Manure decomposes relatively quickly. Uniform forage color and production.	L M H
Severity and Uniformity of Use	Heavy, frequent use. Most or all plants at same height and growth stage.	Patchy or spotty use. Less desirable plants mature, old stems present. Other nearby plants grazed heavily.	Pasture used and reasonably uniformly to appropriate level.	L M H

Remember to assess several places within each field to cover the variability across the area. Record the average scores in the Tame Pasture Scorecard.

**Using your Tame Pasture Assessment:** **High** shows an area that is working well. **Moderate** may be an early warning sign that a problem is developing. **Low** suggests changes in management may improve pasture health and productivity. Follow changes in indicators over time. Note those that show improvement and those that are declining.

## Pasture Assessment Worksheet (Example)

Record the Grazing Days per paddock and use the Animal Days per Acre to compare paddock productivity

Paddock #	Acres per Paddock	Grazing Dates		Grazing Days	Days Rest	Grazing Animals	Animal Units	Animal Grazing Days/Acre	Total per Acre	Total ADA per pad.	Avg. ADA per pad.
		On	Off								
1	26	5/10	5/15	5		50C, 10H	57.5	11	11		
	26	6/25	6/30	5	41	55C	55	11	11		
	26	8/10	8/20	10	41	55C, 20S	70	27	27		
	26	10/15	10/20	5	56	60C/H	60	12	12		
										60	15%
2	27	5/15	5/20	5		50C, 10H	57.5	11	11		
	27	6/15	6/20	5	26	55C, 20S	70	13	13		
	27	7/23	7/30	7	33	55C, 20S	70	18	18		
	27	9/10	9/20	10	42	60C/H	60	22	22		
										64	16%
3	31	5/20	5/25	5		50C, 10H	57.5	9	9		
	31	7/15	7/23	8	51	50C, 10H	57.5	15	15		
	31	8/20	8/28	8	28	55C	55	14	14		
	31	10/20	10/25	5	53	60C/H	60	10	10		
										48	12%
4	32	5/25	5/30	5		50C, 10H	57.5	9	9		
	32	6/20	6/25	5	21	55C, 20S	70	11	11		
	32	7/30	8/5	6	35	55C	55	10	10		
	32	10/5	10/15	10	61	60 C/H	60	19	19		
										49	12%
5	20	5/30	6/5	6		50C, 10H	57.5	17	17		
	20	6/30	7/8	8	25	55C, 20S	70	28	28		
	20	8/28	9/10	13	51	55C	55	36	36		
	20	10/25	10/30	5	45	60 C/H	60	15	15		
										96	24%
6	24	6/10	6/15	5		50C, 10H	57.5	12	12		
	24	7/8	7/15	7	23	50C, 10H	57.5	17	17		
	24	8/5	8/10	5	21	50C, 10H	55	11	11		
	24	9/20	10/5	15	41	60C/H	60	38	38		
										78	20%
<b>ADA=Grazing days/acre; Average ADA=Total ADA divided by the ADA per paddock</b>										395	100%

Use average ADA per paddock to examine your pasture productivity and determine which ones need improvement.

## PastureAssessmentWorksheet

Record the Grazing Days per paddock and use the Animal Days per Acre to compare paddock productivity

Paddock #	Acres per Paddock	Grazing Dates		Grazing Days	Days Rest	Grazing Animals	Animal Units	Animal Grazing Days/Acre	Total per acre	Total ADA per pad.	Avg. ADA per pad.
		On	Off								
1											
2											
3											
4											
5											
6											

## Pasture Facilities Worksheet Example (cost as of 2008)

Acres to be fenced	320	Number of paddocks			8
Fence description	Perimeter	Cross Fence	Alleyway	Total	Total Cost
Fencing (ft)	14,934	10,101	4,618	29,653	
Number of wires	3	1	3		
Number of rolls of wire	12	3	4	18	\$2,681.53
Post - spacing (ft)	30	60	60		
Posts	498	168	77	743	\$3,466.17
Brace assemblies	8	22	12	42	\$336.00
Wires electrified	2	1	3		
Insulators - line	996	168	231	1,395	\$571.95
Insulators - corner	8	22	12	42	\$84.00
Tighteners	12	11	18	41	\$184.50
Tape gate units			8	\$171.12	
Underground gate wire	(for 20 ft wide gates)				\$87.50
<b>Materials</b>					
Cut-out switches	\$9.39	one per paddock			\$195.48
Energizer	\$298.79		Number	1	\$504.99
Solar panels	\$203.00	(11 watt)	Number		\$411.99
Digital Voltmeter	\$60.58		Number	1	\$114.58
Lightening diverter	\$8.89		Number	1	\$32.49
Temporary fencing-polywire	\$48.90	(1659 ft/ roll)	Number		\$0.00
Take up reel	\$61.94		Number		\$0.00
Step-in posts	\$2.87	(per unit)	Number		\$0.00
Screw in anchors	\$7.97	(37 inches)	Number		\$0.00
<b>Total Material Costs</b>				<b>\$8,842.30</b>	
Labor for construction	(estimated at 40% of materials)				\$3,536.92
<b>Total Capital Costs</b>				<b>\$12,379.22</b>	
<b>Material Description</b>					
Wire - ft per roll	3,750	\$141.88	(cost per roll)		
Post cost- line posts	\$4.95				
cross fence	\$3.69				
Braces (2per unit)	\$8.00				
Insulators-line	\$0.41				
Insulators-corners	\$2.00				
In-line Tighteners	\$4.50				
Tape Gate units	\$21.39	for 20 ft wide gates			
Underground wire (165ft)	\$87.50				
Labour (hourly)	\$15.62				
<b>Financial Summary</b>					
<b>Operating Costs:</b>					
Repairs and Maintenance	2.00%	of capital costs			\$247.58
Energy cost	\$2.00	per month			\$24.00
Labour cost	\$31.24	per moth			\$374.88
<b>Fixed Costs:</b>					
Depreciation over 20 years		(per year)			\$618.96
<b>Total Annual Cost</b>					<b>\$1,265.42</b>
<b>Cost per acre</b>					<b>\$3.95</b>

## Pasture Facilities Worksheet

Acres to be fenced			Number of paddocks		
Fence description	Perimeter	Cross Fence	Alleyway	Total	Total Cost
Fencing (ft)					
Number of wires					
Number of rolls of wire					
Post - spacing (ft)					
Posts					
Brace assemblies					
Wires electrified					
Insulators - line					
Insulators - corner					
Tighteners					
Tape Gate units					
Underground gate wire	(for 20 ft wide gates)				
Materials					
Cut-out switches		one per paddock			
Energizer					
Solar panels		( watt)			
Digital Voltmeter					
Lightening diverter					
Temporary fencing-polywire		(1659 ft/ roll)			
Take up reel					
Step-in posts		(per unit)			
Screw in anchors		(37 inches)			
Total Material Costs					
Labor for construction	(estimated at 40% of materials)				
Total Material Costs					
Material Description					
Wire - ft per roll	3,750		(cost per roll)		
Post cost- line posts					
cross fence					
Braces (2per unit)					
Insulators - line					
Insulators - corners					
In-line Tighteners					
Tape Gate units		for 20 ft wide gates			
Underground wire (165ft)					
Financial Summary					
Operating Costs:					
Repairs and Maintenance		%	of capital costs		
Energy cost			per mile		
Labour cost			per mile		
Fixed Costs:					
Depreciation over 20 years					
Total Annual Cost					
Cost per acre					

# Pasture Plan Checklist



- ☐ Sensitive Areas
  - ☐ Sensitive Areas Identified and Described
  - ☐ Management Strategy for Protecting Sensitive Areas
- ☐ Livestock Summary
  - ☐ Livestock Kind and Class
  - ☐ Livestock Number and Average Weight by Herd
- ☐ Fencing System
  - ☐ Kind of Fence Defined
  - ☐ Fence Locations Shown on Map
  - ☐ Length of Fence to be constructed
- ☐ Livestock Watering System
  - ☐ Water Source Identified
  - ☐ Location of Pipelines Shown on Map
  - ☐ Locations of Permanently Placed Tanks Shown on Map
  - ☐ Length of Pipeline and Number of Tanks
  - ☐ Emergency Watering Plans Outlined
- ☐ Heavy Use Area Protection
  - ☐ Locations Shown on Map
- ☐ Forages
  - ☐ Forage Species Identified
  - ☐ Condition of Pastures Documented
  - ☐ Forage Production Estimates Made
  - ☐ Detailed Seeding Plans Prepared
  - ☐ Grazing System Management
  - ☐ Guidance for Initiating and Terminating Grazing
  - ☐ Contingencies for Wet Weather and Drought Defined
- ☐ Grazing Management Prior to Fall Freeze Addressed
  - ☐ Forage Deficiencies and Surpluses Addressed
  - ☐ Sacrificial Paddocks Identified
  - ☐ Rejuvenation of Sacrificial Paddocks Addressed
  - ☐ Livestock Over-wintering Areas Identified
  - ☐ Brush and Weed Control Addressed
  - ☐ Pasture Fertilization Addressed

# Pasture Plan

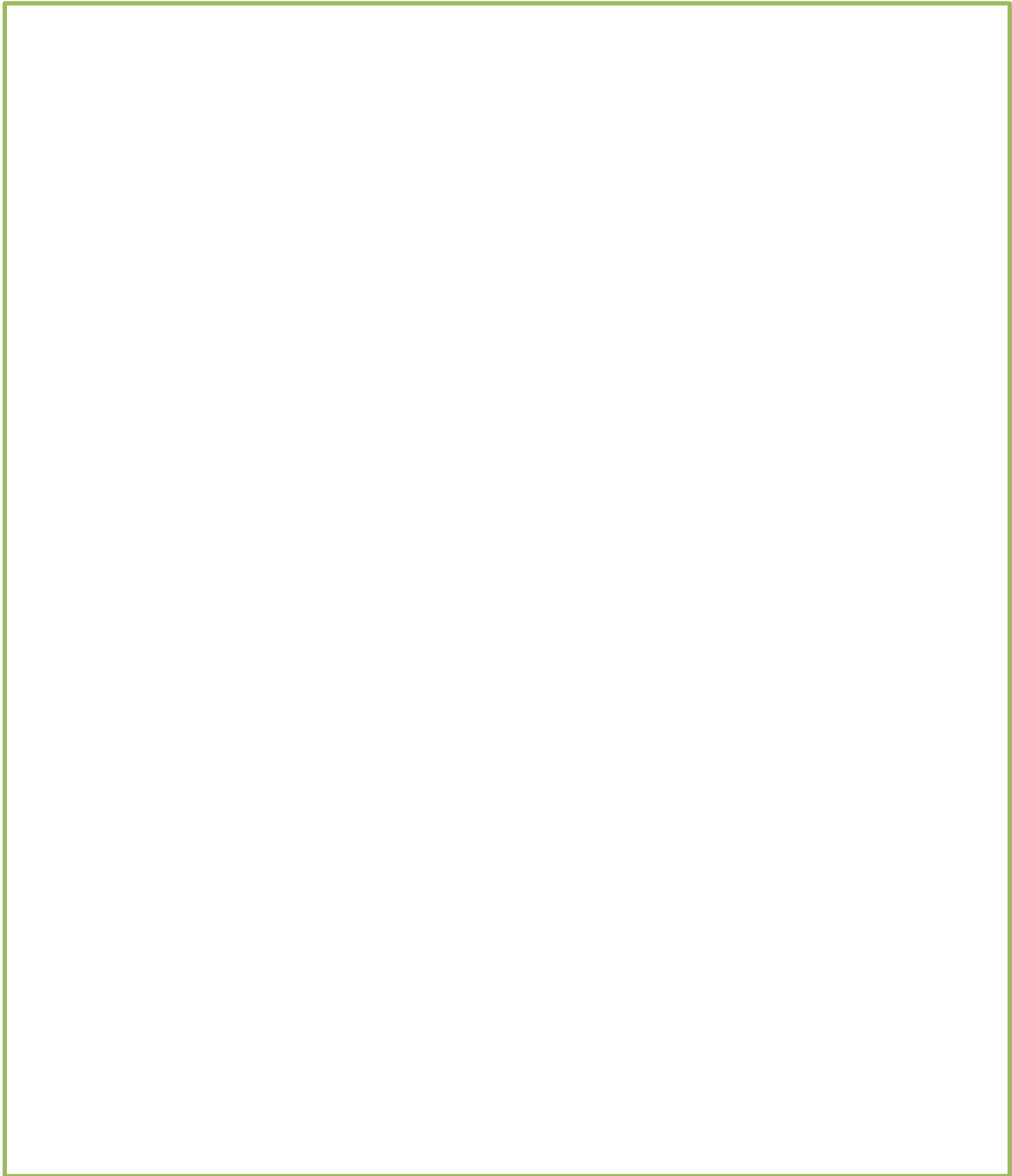
(Sketch out your new fencing plans)



Legend:

-  Two-wire permanent fence
-  Single wire permanent fence
-  Temporary, moveable fencing





# Agricultural Test Weights and Conversions

Ag Decision Maker, Iowa State University Extension and Outreach,  
Department of Economics

**Table 1. Test Weights**

<b>Commodity</b>	<b>Unit</b>	<b>Approximate Weight Pounds</b>	<b>Approximate Weight Kilograms</b>
Alfalfa seed	bu.	60	27.2
Barley	bu.	48	21.8
Beans, dry	bu.	60	27.2
Beans, lima	bu.	56	25.4
Beans, snap	bu.	30	13.6
Bluegrass seed	bu.	14-30	6.3-13.6
Buckwheat	bu.	43-52	19.5-23.6
Clover seed	bu.	60	27.2
Corn, ear (husked)	bu.	70	31.7
Corn, shelled	bu.	56	25.4
Cotton	bale, gross	500	226.8
	bale, net	478	216.8
Cottonseed	bu.	32	14.5
Flaxseed	bu.	56	25.4
Grain sorghums	bu.	56	25.4
Lentils	bu.	60	27.2
Milk	gal.	8.6	3.9
Millet	bu.	48-50	21.8-22.7
Milo	bu.	56	25.4
Mustard seed	bu.	58-60	26.3-27.2
Oats	bu.	32	14.5
Orchard grass seed	bu.	14	6.3
Peas, dry	bu.	60	27.2
Rice, rough	bu.	45	20.4
Rice, rough	bag	100	45.4
Rye	bu.	56	25.4
Soybeans	bu.	60	27.2
Sudangrass seed	bu.	40	18.1
Sweet potatoes	bu.	55	24.9
Timothy seed	bu.	45	20.4
Wheat	bu.	60	27.2

# Alberta Ranchers Winter Grazing Cattle

Alberta Agriculture and Forestry in partnership with Chinook Applied Research Association, Lakeland Agricultural Research Association and West-Central Forage Association, created this series of 47 videos that shares the personal perspectives and practices of ranchers across Alberta and how they have implemented management practices to reduce risk in winter grazing systems. Funding for this project was provided through the Growing Forward 2 program.

The full series can be accessed by clicking on the following link or visit the Alberta Agriculture and Forestry YouTube Channel: <https://youtu.be/dptxdHSOumQ>. Videos can also be accessed at: <http://www.westcentralforage.com/>

## **Fencing:**

[www.youtube.com/playlist?list=PLOUwffF01x2YVtCiWCWzcHUmEUmQn9-mck](http://www.youtube.com/playlist?list=PLOUwffF01x2YVtCiWCWzcHUmEUmQn9-mck)

## **Feed Quality:**

[www.youtube.com/playlist?list=PLOUwffF01x2YUZaOy7Wjegsv\\_SchSvmMfQ](http://www.youtube.com/playlist?list=PLOUwffF01x2YUZaOy7Wjegsv_SchSvmMfQ)

## **Weather:**

[www.youtube.com/playlist?list=PLOUwffF01x2YUiEp5LWGiv1x9xntgh0g\\_3](http://www.youtube.com/playlist?list=PLOUwffF01x2YUiEp5LWGiv1x9xntgh0g_3)

## **Water Accessibility:**

[www.youtube.com/playlist?list=PLOUwffF01x2YXOiFs0jqW8KckDxO\\_LDASr](http://www.youtube.com/playlist?list=PLOUwffF01x2YXOiFs0jqW8KckDxO_LDASr)

## **Animal Type:**

[www.youtube.com/playlist?list=PLOUwffF01x2YX2Q\\_0e8RcnTk8ZeF\\_oIefP](http://www.youtube.com/playlist?list=PLOUwffF01x2YX2Q_0e8RcnTk8ZeF_oIefP)

## **Wildlife:**

[www.youtube.com/watch?v=KpNJzzmBchw&list=PLOUwffF01x2YVXr2cBui0KgskBRwZsKwMr&index=47](http://www.youtube.com/watch?v=KpNJzzmBchw&list=PLOUwffF01x2YVXr2cBui0KgskBRwZsKwMr&index=47)



## **West-Central Forage Association**

Mailing Address:

Box 360

Evansburg AB

T0E 0T0

Office Address:

5009 45 Ave

Entwistle AB

T0E 0S0

780-727-4447

[www.westcentralforage.com](http://www.westcentralforage.com)